



Jayco® Generations of family fun.

2018



TOWABLES

OWNER'S MANUAL



ECO advantage™

THE JAYCO ECOADVANTAGE IS OUR COMPANY'S COMMITMENT TO PROTECTING THE ENVIRONMENT. Through Jayco's company-wide sustainability program, we're creating better ways to build better RV's using fewer natural resources. Already, our initiative has created significant impact.

As of 2014 our company has:

Recycled



- 7,192 tons of wood
- 2,354 tons of scrap metal
- 1,428 tons of cardboard and paper

Conserved



- 9,997,400 gallons of fresh water, enough to meet the daily needs of 133,293 Americans.
- 34,277 gallons of gas, enough for Americans to drive more than 957,600 miles.
- Enough electricity to power 1,745 homes for the year.

Saved



- 60,900 mature trees.
- Enough landfill airspace to meet the annual disposal needs of a community of 44,683 people.

We're proud of our results, and we know those numbers show that a little initiative can go a long way. The Jayco EcoAdvantage is our way of making sure endless generations can enjoy the Great Outdoors.

TABLE OF CONTENTS

SECTION 1: WARRANTY & SERVICE

Options & Equipment	11
Dealer Responsibility	11
Customer Relations	11
To Contact Us	13
About This Manual	13
Warranty Packet	14
Safety Alerts	14
Reporting Safety Defects	15
Customer Responsibility	16
Change Of Address/Ownership	16
Suggestions For Obtaining Service	16
Obtaining Service For Separately Warranted Items	17
Obtaining Service At Our Customer Service Facility	17
Parts & Accessories	17
Notice To Jayco Dealers	22

SECTION 2: OCCUPANT SAFETY

Secondary Means of Escape (Exit Window)	27
<i>Exit Window Label</i>	
Fire Safety	28
Fire Extinguisher	28
Smoke Alarm	29
Combination Carbon Monoxide /Propane Alarm	30
Formaldehyde	33
Extended Or Full Time Usage	33
Cold Weather Usage	34
Condensation	34

SECTION 3: PRE-TRAVEL INFORMATION

Tow Vehicle	35
Vehicle Labels	35
Weight Terms	35
Weight and Capacity Labels	35
<i>OCCC Label (yellow)</i>	
<i>Federal Certification Label</i>	
<i>Tire & Loading Information</i>	
Loading Your Recreation Vehicle	37
Cargo Carrying Accessory Receiver (if so equipped)	37
Rear Bumper	38
Travel Trailer Hitch (customer supplied)	38
Travel Trailer Hitch Weight	39
Travel Trailer Hitch Height & Hitch Ball	39
Travel Trailer Hitching Procedure	39
Wire Harness/Connector Plug	41
<i>7-Way Trailer Plug- car end rear view</i>	
Weighing Your Tow Vehicle & RV	42

SECTION 4: VEHICLE OPERATION

Towing	45
Electric Brakes	46
Towing Behind Your RV	47
Entrance Door Step(s)	48
Entrance Door	48
Rear Backup Camera Prep	49
Campsite Hook-Up	49
(BAL)Leveling System (if so equipped)	50

TABLE OF CONTENTS

Tongue Jack Manual Override:	55
Rear Leveling Jack Leg Override:	55
Stabilizer Jack Manual Override:	56
Stabilizer Jacks	56
Manual Stabilizer Jacks (if so equipped)	56
Electric Stabilizer Jacks (if so equipped)	56
Emergency Stopping	57
Emergency Towing	57
Wheel Lugs	57
Tires	59
Changing A Tire	61
Spare Tire Carrier (if so equipped)	62
<i>Bracket Mount Travel Position</i>	
<i>Hoist Mount Travel Position</i>	
<i>Crank Access Port</i>	
Bumper Mount	63
<i>Bumper Mount</i>	
Setting Up Your Recreation Vehicle	64
Travel Trailer Set Up	64
Fifth Wheel Set Up	64
Awnings (if so equipped)	64
Awning Care	64
Electric Patio Awning With Remote Control	65
In Motion Detector (if so equipped)	65
Power Awnings (if so equipped)	65
Carefree® Longitude Awnings (if so equipped)	65
Carefree® Travel'r Awnings (if so equipped)	67

SECTION 5: SLIDEOUT SYSTEMS

Electric Slide Room(s) (if so equipped)	69
General Slideout Operation:	69
<i>Slideout Overlap-Outside</i>	
General Slideout Troubleshooting Checklist	70
Flush Floor Slideout	70
Schwintek In-Wall Slideout System	72
Error Codes	75
Norco Slideout System	75
Norco Slideout Manual Operation	76
Power Gear Slideout System	77
<i>Fig.1 Slideout Controller</i>	
Power Gear Slim Rack Slideout System	78
Operating the Slideout	79
Power Gear Ram Slideout System	82

SECTION 6: ELECTRICAL SYSTEM

The Electrical System	85
Command Center	85
<i>Command Center Panel</i>	
GFCI Receptacle	86
<i>Command Center Panel W/Switch Modules</i>	
5-Way & 8-Way Power Remote (if so equipped)	87
Batteries	89
Testing The Campsite Power Connection	90
Connecting The Power Cord	91
Power Converter	91
Converter With Charge Wizard (if so equipped)	92

TABLE OF CONTENTS

12-Volt DC System	93
12-Volt Fuse Panel	93
Auxiliary Battery (customer supplied)	94
Replacing A Fuse	94
12-Volt DC Outlet	94
Dry Camping	95
Replacement and Maintenance	95
Battery Isolator For Your Tow Vehicle (customer supplied)	95
Battery Disconnect Switch (if so equipped)	95
Load Center	96
120-Volt Circuit Breakers	96
<i>Typical Load Center Panel</i>	
<i>Battery Disconnect Switches</i>	
Approximate Electrical Load Ratings	98
120-Volt (30 AMP) AC System (if so equipped)	99
30-AMP Power Cord (if so equipped)	99
120-Volt (50 AMP) AC System (if so equipped)	100
Calculating 30 AMP Electrical Load (if so equipped)	100
50-AMP Power Cord (if so equipped)	101
Calculating 50 AMP Electrical Load (if so equipped)	101
Solar Prep (if so equipped)	102
Replacing Light Bulbs	102
Exhaust Gas Fumes	102
<i>Solar Plug</i>	

SECTION 7: FUEL & PROPANE SYSTEM

Propane Gas System	103
Propane Gas Container	103
Servicing or Filling	105
<i>“Use propane only” Label (Canada only)</i>	
<i>“Shut off for re-fueling” Label</i>	
<i>“Do not fill to more than 80%” Label</i>	
LP Gas Container Overfill	106
Maintenance	106
Propane Cylinder Recertification	106
Hoses, Pipes, Tubes & Fittings	106
Propane Regulator	107
Propane Use and Safety	108
Propane Leak Test	108
Using The Propane System	108
<i>Propane System Label</i>	
Cooking With Propane Gas	109
Calculating Propane Gas Usage	109
<i>Cooking / Comfort Heating Label</i>	
Traveling With Propane	110
Installing Propane Cylinder(s)	110
<i>Refueling Warning Label</i>	
<i>Single Cylinder</i>	
<i>Main Supply Hose</i>	
<i>Double Cylinder</i>	
<i>Two Propane Cylinders</i>	

SECTION 8: PLUMBING SYSTEM

Plumbing System	113
Plumbing System Maintenance	113
Monitor Panel	113

TABLE OF CONTENTS

<i>Monitor Panel</i>	
<i>Command Center</i>	
Operation	114
Fresh Water System	115
Water Pressure Regulator (customer supplied)	115
Fresh Water Holding Tank	115
12-Volt Water Pump & Switch	115
Fresh Water Connections	116
<i>City Water Fill with City Water Connection label</i>	
Potable Water Label	
Gravity Water Fill	
Draining The Fresh Water System	118
Sanitizing/Winterizing The Plumbing System	118
<i>Low Point Drains</i>	
<i>Exterior Fresh Water Drain</i>	
How to sanitize	119
<i>Water heater drain plug location</i>	
Water Heater	125
Operating Instructions:	125
High Altitude Deration	127
Pressure and Temperature Relief Valve	127
<i>Anode rod replacement chart</i>	
Outside Shower (if so equipped)	128
Maintenance	128
Draining and Winterization:	128
Macerator Pump System (If So Equipped)	129
Faucets	131
Bathroom Tub / Shower	131
Black/Grey Water System and Tanks	131
Black/Grey Water Holding Tanks	132
Black & Grey Tank Drains	133
<i>Black/Grey Tank Drain & Valves</i>	
Black Tank Flush (if so equipped)	134
<i>Tank Flush Inlet</i>	
Toilet	135
SECTION 9: HEATING & COOLING	
<hr/>	
Air Conditioner	137
Roof Mount (if so equipped)	137
Wall Mount (if so equipped)	137
Heat Pump Operation (if so equipped)	137
Power Roof Vent (if so equipped)	137
<i>Attic Fan Control</i>	
Furnace	138
Microwave	138
SECTION 10: APPLIANCES	
<hr/>	
Cooking Safety	139
In Case Of a Grease Fire	139
Cooking With Propane (if so equipped)	139
Cooktops; Range & Oven (if so equipped)	140
Electric Drop-In Cooktops (if so equipped)	140
Gas Drop-In Cooktops (if so equipped)	141
Kitchen Range & Oven (if so equipped)	141

TABLE OF CONTENTS

Oven (if so equipped)	141
Gas BBQ Grill (if so equipped)	142
<i>Bumper Mounting Bracket</i>	
Attaching the “Quick Coupler” Connection	143
Range Hood (if so equipped)	143
<i>Quick Connect Coupler</i>	
<i>Gas Grill & Mounting</i>	
<i>Bracket on Support Rail</i>	
<i>Range Hood Vent</i>	
Refrigerator	144
Cleaning The Interior	145
Cleaning The Exterior	145
Washer/Dryer Prep (if so equipped)	146
Water Heater – See Plumbing Section	146
Outside Kitchen (if so equipped)	146
<i>Dryer Vent Label</i>	
Exterior Refrigerator	147
LP Gas Grill (if so equipped)	147
<i>Quick Connect Coupler</i>	
Cleaning The Grill	148

SECTION 11: ELECTRONICS

HDTV Antenna/Satellite System(s)	149
HDTV Antenna (if so equipped)	149
Antenna Power Supply (if so equipped)	149
Satellite (if so equipped)	149
<i>Antenna Power Supply</i>	

SECTION 12: INTERIOR

Cleaning The Interior	151
Window Treatments	151
Window Shades	151
Cabinetry & Tables	152
Interior Wall Panel	152
ABS Plastics	153
Sofa & Dinette	153
Hide-A-Bed Sofa or Sofa Sleeper	153
Jack Knife Sofa	153
Trifold Sofa	153
Cube Sofa	153
Pantry or Hutch (if so equipped)	154
Countertops	154
Booth Dinette (if so equipped)	154
Free-Standing Table & Chairs (if so equipped)	154
Laminate Countertops (if so equipped)	155
Solid Surface Countertops (if so equipped)	155
Flooring	155
Carpet	155
Vinyl flooring	155
Murphy Bed (if so equipped)	156
Unfolding The Sofa	156
<i>Stored Position</i>	
<i>Sleeping Position</i>	
Lowering The Murphy Bed	157
Storing The Murphy Bed	158
Bed Storage	158

SECTION 13: EXTERIOR

Cleaning The Exterior	159
Frame	161
E-Z Lube or Super-Lube Axle (if so equipped)	161
Exterior Roof & Sidewall Vents	162
Windows	162
Exterior Ladder (if so equipped)	162
Sealants	163
Travel Trailers - Sealant Diagram	164

SECTION 14: TRAVEL/CAMPING/STORAGE CHECKLISTS

Travel Checklist	165
RV Storage	166

SECTION 15: ADDITIONAL INFORMATION

Featured Components Quick Reference Chart	169
Vehicle Maintenance Record	171



WARNING: Read all instructions in this manual and component manufacturer supplied information before using your RV.

This manual has been provided by your recreational vehicle manufacturer for the sole purpose of providing instructions concerning the operation and maintenance of this recreational vehicle. Nothing in this manual creates any warranty, either expressed or implied.

The owner's failure to provide required service and/or maintenance could result in the loss of warranty. Please review the limited warranty and the limited warranties that apply to specific components offered with this vehicle.

Instructions are included in the manual for operating various components which are optional on some RV's or may not be available on your particular model. **“If so equipped” does not indicate or imply that the component(s) or option(s) were at any time available, or can be retrofitted to your model.** In addition, the owner should refer to individual manufacturer's operating instructions contained in the owner's packet.

Congratulations! Thank you for selecting a Jayco recreation vehicle. We are excited to welcome you to our growing RV family. We are committed to being the most respected name in RVs. We invite you to drop by our Visitors Center located in Middlebury, Indiana. To book a group tour or check our scheduled factory tour times (free admission, closed holidays) please call 1-800-RV-JAYCO.

Jayco recreation vehicles are manufactured for use as temporary living quarters for recreation, camping and travel uses, all as defined by the bylaws of the Recreation Vehicle Industry Association (RVIA).

This recreation vehicle is not intended for use as a full-time residence or for commercial use. Commercial use means using the recreation vehicle as a business asset such as a mobile office or using the recreation vehicle for lease or rental purposes.

Jayco reserves the right to discontinue or change specifications or design at any time without notice and without incurring any obligation whatsoever. Recreation vehicles built for sale in Canada may differ to conform to Canadian Codes.

Options & Equipment

Jayco recreation vehicles are available in several sizes and models, so accessories and components may differ slightly between models. Some equipment described in this manual may not apply to your recreation vehicle.

Jayco reserves the right to discontinue or change specifications or design at any time without notice, and to make additions or improvements without incurring any obligations upon itself to install these changes on its products previously manufactured. Recreation vehicles built for sale in Canada may differ to conform to Canadian Codes.

Dealer Responsibility

At the time of sale of the new recreation vehicle, your Jayco dealer is expected to:

- Deliver your recreation vehicle in the best condition possible. Your recreation vehicle must pass the dealer's pre-delivery inspection (PDI), including all systems tests.
- Provide orientation of the recreation vehicle, its systems, components and operation.
- Request that you read all warranty information and explain any provision not clearly understood.
- Ensure you receive the Warranty Packet. Your dealer can assist you in completing the OEM warranty cards or registrations, and locate any required component model or serial numbers.
- Complete and return the "Warranty Registration and Customer Delivery Form" to Jayco within 10 days of delivery to activate the applicable warranty coverage.

The **Limited Warranty** is activated only after Jayco receives a signed and dated "Warranty Registration and Customer Delivery Form" from your dealer.

Customer Relations

Jayco has empowered its dealers to make warranty and repair decisions.

If a special circumstance occurs that requires information from Jayco, we have asked your dealer's service management to make the contact on your behalf. **This is why you should always talk to your dealer's service management first.**

SECTION 1: WARRANTY & SERVICE



NOTE: Please provide the following information when contacting us for assistance:

- Customer name and current location.
- Phone number where you can be reached.
- 17-digit chassis Vehicle Identification Number (VIN) or 9-digit Serial
- The current vehicle mileage (motor homes)
- Your date of purchase.
- If applicable, the component description, serial number and model number.
- A detailed description of the concern.
- The name of your selling dealer.
 - If different from above, the contact information for the RV repair facility you are contacting Jayco to discuss.

An important note about alterations and warranties

Installations or alterations to the original equipment vehicle as distributed by Jayco are not covered by the Jayco Limited Warranty. The special body company, assembler, equipment installer or up fitter is solely responsible for warranties on the body or equipment and any alterations (or any effect of the alterations) to any of the parts, components, systems or assemblies installed by Jayco. Jayco is not responsible for the safety or quality of design features, materials or workmanship of any alterations by such suppliers.

Obtaining Emergency Warranty Repair

1. Call 1-800-RV-JAYCO or use our website dealer locator to find an authorized Jayco dealer in your area. Contact them for an appointment; they will handle all warranty repair billing and returned parts for you.
2. If you cannot locate an authorized Jayco dealer near you, ask the campground staff for referrals or check the local telephone yellow pages. Or contact Jayco Customer Service or your selling dealer for assistance in locating a repair facility.
 - Contact the RV repair facility to discuss your situation and make an appointment. Ask how their billing will be handled. They may choose to bill Jayco directly; otherwise, you are expected to pay them.
 - Have the RV repair facility inspect your RV. Either they or you must call Jayco Customer Service to discuss applicable warranty coverage prior to any repair work being performed.
 - Jayco Customer Service will issue an authorization number upon warranty repair approval and advise if any original parts need to be returned.
 - Once Jayco Customer Service has issued an authorization number, the RV repair facility may begin actual repair to your RV.
 - Inspect the completed repair work thoroughly. If you are not satisfied, communicate that immediately to the RV repair facility management. Make sure you are satisfied with the repair before you pay or leave the premises.
 - For reimbursement, either you or the RV repair facility must send a copy of your itemized repair bill and all requested return parts by UPS (regular ground, freight pre-paid) within 60 days of the completed repair date.

SECTION 1: WARRANTY & SERVICE

To expedite processing your warranty claim, include your name, address, phone number, RV 17-digit VIN and authorization number. If returning parts, include a copy of your return freight bill.

Obtaining weekend or after business hours repair assistance

If an authorized Jayco dealer is not located nearby, contact your selling dealer for assistance. If your dealer is closed, check with the campground staff or telephone yellow pages for an RV repair facility. Have the item repaired and contact Jayco Customer Service immediately the following business day.

Failure to contact Jayco Customer Service, unauthorized or improper warranty repairs, or failure to return requested original parts may result in loss of reimbursements and/or loss of warranty.

To Contact Us

Mailing address

Jayco, Inc.
Customer Service
P.O. Box 460
903 S. Main Street
Middlebury IN 46540
Phone (toll-free)
Phone (local)
Fax (toll-free)
Brochure request
Parts email
Service email
Website

Shipping address

Jayco, Inc.
Customer Service
100 Bontrager Drive
Bldg 42 Door 4220
Middlebury IN 46540
(800) 283-8267
(574) 825-0608
(866) 709-9139
info@Jayco.com
parts@Jayco.com
service@Jayco.com
www.Jayco.com

Jayco Travel Club

All owners of Jayco recreation vehicles are eligible for membership in the Jayco Travel Club.

The club promotes family camping and the active use of your RV with others who have similar interests in the RV lifestyle.

One "International Rally" is held each year in various locations around the United States and Canada. In addition, the club offers a variety of local and regional activities throughout the year.

By belonging to the Jayco Travel Club, you will find new ways to enjoy your RV and make friends all across the country.

For more information, please visit www.Jaycorvclub.com or call 1-800-262-5178.

ABOUT THIS MANUAL

This manual is a guide to operation of the features, equipment and controls in your recreation vehicle. If you find components vary significantly from what is described, please contact your dealer to ensure you have the correct information. Nothing in this manual creates any warranty, either expressed or implied.

This Owner's Manual and Warranty Packet are to be considered permanent components of the vehicle. Keep them in your recreation vehicle at all times for personal reference. If the recreation vehicle is sold, they should remain with the vehicle for the next owner. Nothing

SECTION 1: WARRANTY & SERVICE

in this manual creates any warranty, either expressed or implied, nor does it cover every possible detail of equipment, standard or option, installed on or in your recreation vehicle.

Information, illustrations and specifications in this manual reflect the most current available at the time of publication approval, are subject to change and not intended to indicate actual size.

WARRANTY PACKET

There are components that are excluded from the vehicle warranty, or are warranted separately by their own individual manufacturer's limited warranty. The Warranty Packet contains these component manufacturer supplied manuals or information sheets, warranty cards and/or registrations. Consult this information for questions regarding operating, maintenance, servicing instructions and warranty coverage. It is important you complete and mail warranty cards and registrations within the prescribed time limits to avoid loss of warranty coverage.

SAFETY ALERTS

Throughout this manual, certain items are labeled **NOTE**, **CAUTION**, **WARNING**, and **DANGER**. These terms will alert you to precautions that can involve risk to your vehicle or to your personal safety.

Read and follow them carefully. National Safety Associations and organizations require many of the instructions listed. Always use the appropriate safety gear when servicing or maintaining your recreation vehicle. Please call your dealer or our customer service representatives if you are unsure how to proceed.

These signal words indicate precautions and potential situations, which if not avoided, may result in personal injury, property damage, or damage to your recreation vehicle. These precautions are listed in the appropriate areas in this Owner's Manual, and in the information contained in the Warranty Packet, and on safety labels affixed to your recreation vehicle. Read and follow them carefully.



NOTE: Gives helpful information.



This is the safety alert symbol. It is used to alert you to potential personal injury hazards. Obey all safety messages that follow this symbol to avoid possible injury or death.

NOTICE

Indicates a potential situation that, if not avoided, may result in property damage or damage to your RV.



CAUTION

Indicates a potentially hazardous situation that, if not avoided, may result in minor or moderate injury. It may also be used to alert against unsafe practices.

 DANGER

Indicates an imminently hazardous situation that, if not avoided, will result in death or serious injury. This alert information is limited to the most extreme situations.

 WARNING

Indicates a potentially hazardous situation that, if not avoided, may result in death or serious injury.

REPORTING SAFETY DEFECTS

In the United States: If you believe that your recreation vehicle has an alleged defect which could cause a crash or cause injury or death, you should immediately inform the National Highway Traffic Safety Administration (NHTSA), in addition to notifying our Customer Service Department.

If NHTSA receives similar complaints, it may open an investigation, and if it finds that a safety defect exists in a group of vehicles, it may order a recall and remedy campaign.

However, NHTSA cannot become involved in individual problems between you, your dealer or your vehicle manufacturer. For additional information, please refer to the NHTSA website at www.safercar.gov.

To contact NHTSA by phone:

Call the Department of Transportation (DOT) Vehicle Safety Hotline at 1-888-327-4236, and a NHTSA representative will record your complaint information (TTY: 1-800-424-9153 or 1-202-484-5238).

To Contact NHTSA by mail:

Office of Defects Investigations/CRD
NVS-216
1200 New Jersey Ave SE
Washington, DC 20590

In Canada: If you believe your vehicle has an alleged safety defect, you should contact Transport Canada and our Customer Service Department immediately. Transport Canada prefers to be called instead of posted mail or email as it enables their investigators to confirm that your information is correct, and to answer your questions accurately. For additional information, please refer to the Transport Canada website at www.tc.gc.ca.

To contact Transport Canada by phone:

Call 1-800-333-0510 (or 1-613-993-9851 if you are calling from the Ottawa region) and ask to speak to a defect investigator.

To contact Transport Canada by mail:

Road Safety and Motor Vehicle
Regulation Directorate
Transport Canada
Tower C, Place de Ville
330 Sparks Street
Ottawa, Ontario K1A 0N5

SECTION 1: WARRANTY & SERVICE

CUSTOMER RESPONSIBILITY

It is important you read and understand all instructions and precautions before operating the recreation vehicle. Even if you are an experienced RV'er we encourage you to thoroughly read this Owner's Manual, as well as the information contained in your Warranty Packet and Chassis Guide (motorized only).

As technology advances, new improvements enter the RV industry every day, and each RV manufacturer has its own unique manufacturing process.

Familiarize yourself with the Limited Warranty applicable to your recreation vehicle. There are components that are excluded or warranted separately by their individual manufacturer's limited warranty (refer to the Warranty Packet or Chassis Guide if applicable).

As the new owner of the recreation vehicle, you are responsible for regular and proper maintenance performed in accordance with this manual and the OEM manuals. Regular and proper maintenance will help prevent conditions arising from neglect that are not covered by the limited warranty. It is your responsibility and obligation to return your vehicle to your dealer for repairs and service.

CHANGE OF ADDRESS/OWNERSHIP

Please notify our Customer Service Department as soon as possible of a change of address by writing or calling us. For notification of a change of ownership, please fill out the appropriate form located in this manual and mail it to Customer Service along with documentation showing proof of ownership. Please include your current vehicle mileage (motorized only).

SUGGESTIONS FOR OBTAINING SERVICE

To help ensure your dealer provides the level of service you expect, here are some suggestions we would like to make:

Contact your dealer at once... Do not wait until you are ready to use your RV. Your dealer may not be able to service it immediately and/or the repair may require parts be ordered. The dealer's service department is busiest on Mondays, Fridays and before the holidays.

Prepare for the appointment... If you are having warranty work performed, be sure to have the right papers with you. Take your warranty folder and have your vehicle information available. All work to be performed may not be covered by the warranty. Discuss additional charges with the service personnel.

Prepare a list... Provide your dealer with a written list of specific repairs needed. It is important that you provide any vehicle repair history to the dealer's service personnel.

Keep a maintenance log of your vehicle's service history. This can often provide a clue to the current issue.

Be reasonable with your requests... If you leave a list with several items and you need your vehicle returned back by a specific time, discuss the situation with the dealer's service personnel and list your items in order of priority. This may include making a second appointment for work not completed or parts that the dealer may need to order.

Don't expect to look over the technician's shoulder... Please don't be offended if you are told you cannot watch the work being done. Some insurance requirements forbid admission of customers to the service area.

Inspect the work performed... Finally, check out the service or repair job when you pick up your vehicle. Notify the dealer's service personnel immediately of any dissatisfaction. If you cannot return the vehicle immediately for repair, make an appointment as soon as possible.

Please be aware that all service shops require notification of any issues with their repairs within a specified time limit. Make sure you are familiar with their repair policies.

OBTAINING SERVICE FOR SEPARATELY WARRANTED ITEMS

Your selling dealer is responsible for servicing your recreational vehicle before delivery, and has an interest in your continued satisfaction. We recommend your dealer perform all inspection, warranty and maintenance services. Some dealers may be authorized service centers for those OEMs whose products are warranted separately and excluded from the **Limited Warranty**.

OBTAINING SERVICE AT OUR CUSTOMER SERVICE FACILITY

Should your recreation vehicle be in need of service, and your dealer recommends that the repairs be made at our Customer Service facility, your recreation vehicle may be returned to us with the following guidelines*:

- You or your dealer must make a confirmed appointment 60 days prior to dropping off the recreation vehicle at our Customer Service facility.
- The holding tanks must be emptied and rinsed. We have a dumping station available for customer use.
- The propane system (if so equipped) and all electrical systems must be shut down and turned off. We are not responsible for discharged batteries or propane tanks.
- During the appropriate season, please ensure the RV has been winterized.
- Unless prior approval has been obtained from our Customer Service facility, all personal items must be removed from the area where you are requesting service repair and the refrigerator emptied. We are not responsible for loss of food items.
- All transportation costs are the responsibility of the owner. You may need to arrange for alternative accommodations for some types of repairs. Please be prepared accordingly.

**Our Customer Service facility occasionally utilizes local independent repair facilities. Your vehicle may be referred to or repaired by one of these local repair facilities.*

PARTS & ACCESSORIES

Contact your authorized dealer for assistance in obtaining replacement parts or accessories. We do not sell direct to retail or non-authorized dealers. If the original part is no longer available, we will make every effort to provide an appropriate substitute.

TOWABLE LIMITED WARRANTY

WHAT AND WHO IS COVERED

The Jayco warranty covers this recreational vehicle (“RV”), when used only for its intended purpose of recreational travel and camping, for two (2) years. It covers RV’s that are sold in, and remain in, the United States, U.S. Territories and Canada, only. The warranty period begins on the date that the RV is delivered to the first retail purchaser by an independent, authorized dealer of Jayco, or, if the dealer places the vehicle in service prior to retail sale, on the date the RV is first placed in such service. In the event that a substantial defect in material or workmanship, attributable to Jayco, is found to exist during the warranty period, it will be repaired or replaced, at Jayco’s option, without charge to the RV owner, in accordance with the terms, conditions and limitations of this limited warranty.

This limited warranty applies to the first consumer purchaser only. All rights and limitations within this warranty are applicable to the original owner of the RV only. Jayco’s limited warranty only covers substantial defects in materials, components, or parts of the RV attributable to Jayco. It does not replace, modify, or apply to the warranties provided by the manufacturers that supply the products used by Jayco to assemble the RV, like the frame. You may contact an independent, authorized dealer for details.

Jayco’s obligation to repair or replace defective materials or workmanship is the sole obligation of Jayco under this limited warranty. Jayco reserves the right to use new or remanufactured parts of similar quality to complete any work, and to make parts and design changes from time to time without notice to anyone. Jayco reserves the right to make changes in the design or material of its products without incurring any obligation to incorporate such changes in any product previously manufactured. Jayco makes no warranty as to the future performance of this RV, and this limited warranty is not intended to extend to the future performance of this RV, or any of its materials, components or parts. In addition, the RV owner’s obligation to notify Jayco, or one of its independent, authorized dealers, of a claimed defect does not modify any obligation placed on the RV owner to contact Jayco directly when attempting to pursue remedies under state or federal law.

LIMITATIONS, EXCLUSIONS AND DISCLAIMER OF IMPLIED WARRANTIES: ANY IMPLIED WARRANTY THAT IS FOUND TO ARISE BY WAY OF STATE OR FEDERAL LAW, INCLUDING ANY IMPLIED WARRANTY OF MERCHANTABILITY OR ANY IMPLIED WARRANTY OF FITNESS, IS LIMITED IN DURATION TO THE DURATION SET FORTH IN THIS LIMITED WARRANTY AND IS LIMITED IN SCOPE OF COVERAGE TO THE SCOPE OF COVERAGE OF THIS LIMITED WARRANTY.

Jayco makes no warranty of any nature beyond that contained in this limited warranty. Jayco does not authorize any person to create any other obligation or liability for it regarding this RV, and Jayco is not responsible for any representation, promise or warranty made by any dealer or other person beyond what is expressly stated in this limited warranty, and no one has the authority to enlarge, amend or modify this limited warranty. Any selling or servicing dealer is not Jayco’s agent, but an independent entity.

JAYCO SHALL NOT BE LIABLE FOR ANY INCIDENTAL OR CONSEQUENTIAL DAMAGES THAT MAY RESULT FROM BREACH OF THIS LIMITED WARRANTY OR ANY IMPLIED WARRANTY. THIS EXCLUSION OF CONSEQUENTIAL AND INCIDENTAL DAMAGES SHALL BE INDEPENDENT OF ANY FAILURE OF THE ESSENTIAL PURPOSE OF ANY WARRANTY, AND THIS EXCLUSION SHALL

SURVIVE ANY DETERMINATION THAT THIS LIMITED WARRANTY OR ANY IMPLIED WARRANTY HAS FAILED OF ITS ESSENTIAL PURPOSE.

Some states do not allow limitations on how long an implied warranty lasts, or the exclusion or limitation of incidental or consequential damages, so the above limitations or exclusions may not apply to you.

HOW TO GET SERVICE

To obtain warranty service the owner must do all of the following:

1. Notify an independent, authorized dealer of Jayco, or Jayco, of the substantial defect in material or workmanship attributable to Jayco, within the warranty coverage period designated above;
2. Provide the notification mentioned in (1), above, within ten (10) days of when the owner discovered, or should have discovered, the substantial defect in material or workmanship attributable to Jayco;
3. Promptly schedule an appointment with and take the RV to an independent, authorized dealer of Jayco, or Jayco, for repairs; and
4. Pay any freight or transportation costs, import duties, fees and all incidental expenses associated with obtaining warranty service.

For warranty service simply contact one of Jayco's independent, authorized service centers for an appointment and then deliver your RV to the service center on the specified appointment date. If you need assistance you may contact Jayco, at 903 S. Main Street, P.O. Box 460, Middlebury, Indiana 46540, Attn: Customer Service, (574) 825-5861, (800) 283-8267 or www.jayco.com.

NOTE: Jayco does not control the scheduling of service work at the independent, authorized dealerships. You may encounter some delay in scheduling or completion of work. Also, you must notify the selling dealer at time of delivery to have work performed on any defect that occurred at the factory during manufacture at no cost to you as provided by this limited warranty. (See below under **WHAT IS NOT COVERED**).

If two (2) or more service attempts have been made to correct any covered defect that you believe impairs the value, use or safety of the RV, or if it has taken longer than thirty (30) days for those types of repairs to be completed, you must, to the extent permitted by law, notify Jayco directly, in writing, at the above address, of the unsuccessful repair(s) of the alleged defect(s) so that Jayco can become directly involved in making sure that you are provided service pursuant to the terms of this limited warranty.

WHAT IS NOT COVERED

By way of example only, this limited warranty does not cover any of the following: defects in materials, components or parts of the structure of the RV not attributable to Jayco; items that are added or changed after the RV leaves the possession of Jayco; additional equipment or accessories installed at any dealership, or other place of business, or by any other party, other than Jayco; any RV used for rental or other commercial purposes (Note: It shall be concluded that the RV has been used for commercial and/or business purposes if the RV owner or user files a tax form claiming any business or commercial tax benefit related to the RV, or if the RV is purchased, registered or titled in a business name); any RV sold or used outside the United States, U.S. Territories or Canada; any RV not used solely for recreational travel and camping; any RV purchased through auction or wholesale; any RV purchased from a dealer that is not an authorized dealer of Jayco; excess weight placed on

SECTION 1: WARRANTY & SERVICE

the Structural Components; normal wear, tear or usage, such as tears, punctures, soiling, mildew, fading, or discoloration of exterior plastic or fiberglass, or soft goods, such as upholstery, drapes, carpet, vinyl, screens, cushions, mattresses and fabrics; the effects of condensation or moisture from condensation inside the RV; mold or any damage caused by mold to the inside or outside of the RV; imperfections that do not affect the suitability of the RV for its intended purpose of recreational use or items that are working as designed but that you are unhappy with; exterior paint or finish which is warranted independently by the paint manufacturer and/or independent applicator; problems, including water leaks, related to misuse, mishandling, neglect or abuse, including failure to maintain the RV in accordance with the owner's manual, or other routine maintenance such as inspections, lubricating, adjustments, tightening of screws and fittings, tightening of lug nuts, sealing, rotating tires; damage due to accident, whether or not foreseeable, including any acts of weather or damage or corrosion due to the environment, theft, vandalism, fire, or other intervening acts not attributable to Jayco; damage caused by unregulated water pressure, tank over fill, or plumbing system modifications resulting in flooding of the vehicle; failure of the original retail purchaser or others to follow ordinary maintenance procedures as recommended by Jayco; damage caused by unprotected electrical hook-ups (home or campground), power surges, lightning, circuit overload, or electrical system modifications; damage resulting from tire wear or tire failure; defacing, scratches, dents, chips on any surface or fabric of the RV; damage caused by infestation by insects or other animals; damage caused by off road use, overloading the RV or alteration of the RV, or any of its components or parts; wheel alignment or adjustments to axles when caused by improper maintenance, loading or damage from road hazards, including off road travel, wheel damage or balancing or damage from tire failures. Also, any costs associated with obtaining service, including by way of example, travel costs, are specifically excluded from the coverage of this warranty.

In addition, this limited warranty does not cover any material, component or part of the RV that is warranted by another entity, including, by way of example, handling, braking, wheel balance, tires, tubes, batteries, gauges, generator, hydraulic jacks, inverter, converter, microwave, television, DVD/CD player, radio, speakers, television, refrigerator, range, hot water heater, water pump, stove, carbon monoxide detector, smoke detector, propane detector, furnace or any air conditioner. (Note: The written warranty provided by the manufacturer of the component part is the direct responsibility of that manufacturer).

Defects and/or damage to interior and exterior surfaces, trim, upholstery and other appearance items may occur at the factory. These items are usually detected and corrected at the factory or by the selling dealer prior to delivery to the retail customer. You must inspect your RV for this type of damage when you take delivery. If you find any such defect or damage you must notify the selling dealer at time of delivery to have these items covered by this limited warranty and to have work performed on the items at no cost to you as provided by this limited warranty.

EVENTS DISCHARGING JAYCO FROM OBLIGATION UNDER WARRANTY

Certain things completely discharge Jayco from any obligation under this warranty and void it. By way of example, the following shall discharge Jayco from any express or implied warranty obligation to repair or replace any defect that results from: any rental or other commercial use or purchase of the RV (as defined in this warranty), any RV sold outside of, or used outside of, the United States, U.S. Territories or Canada, through an auction or

wholesale or by a non-authorized dealer, any defect in a separately manufactured component part, owner neglect or failure to provide routine maintenance (See Owner's Manual), unauthorized alteration, off road use, collision or accident, whether or not foreseeable, including any acts of weather or damage or corrosion due to the environment, theft, vandalism, fire, explosions, overloading in excess of weight ratings, and tampering with any portion of the RV, or any use of the RV as a semi-permanent or permanent home.

LEGAL REMEDIES

Any action to enforce any portion of this limited warranty, or any implied warranty, shall be commenced within six (6) months after expiration of the warranty coverage period designated above. Any performance of repairs shall not suspend this limitation period from expiring. Any performance of repairs after the warranty coverage period has expired, or performance of repairs regarding anything excluded from coverage under this limited warranty shall be considered "good will" repairs, and they will not alter the express terms of this limited warranty, or extend the warranty coverage period or this limitation period. In addition, this warranty is not intended to extend to future performance, and nothing in this warranty, or any action of Jayco, or any agent of Jayco, shall be interpreted as an extension of the warranty period or this limitation period. Some states do not allow a reduction in the statute of limitations, so this reduction may not apply to you.

WARRANTY REGISTRATIONS

Your warranty registration records should be completed and delivered to the manufacturers of component parts. The selling dealership will assist you in completing and submitting the Jayco product warranty registration form. That form must be returned to Jayco within ten (10) days of your taking delivery of the RV. Your Jayco warranty will not be registered unless this warranty registration is completed and received by Jayco. Failure to file this warranty registration with Jayco will not affect your rights under this limited warranty as long as you can present proof of purchase, but it can cause delays in obtaining the benefits of this limited warranty, and it may inhibit any servicing facility's ability to provide proper repairs and/or part replacement.

CARE AND MAINTENANCE

It is the owner's responsibility to perform proper care and maintenance of the RV, and to assure correct load distribution. For details regarding this, please see your Jayco owner's manual and the owner's manuals of the chassis manufacturer and other component part manufacturers. These outline various care and maintenance that is required to maintain your RV. Please review all manuals supplied with your RV, and contact your selling dealership or supplier of the component part if you have questions. Note: Failure to maintain the RV as noted in those manuals voids this limited warranty, and any damage to the RV as a result of your failure to perform such care, is not covered by this limited warranty.

THIS WARRANTY GIVES YOU SPECIFIC LEGAL RIGHTS, AND YOU MAY ALSO HAVE OTHER RIGHTS THAT VARY FROM STATE TO STATE.

JAYCO, INC.

903 S. Main Street * P.O. Box 460 * Middlebury, IN 46540

Telephone: 574-825-5861 or 800-283-8267

SECTION 1: WARRANTY & SERVICE

NOTICE TO JAYCO DEALERS

This Owner's Manual contains the *Towable Limited Warranty* that applies to this RV. However, if the Jayco dealer decides to use this RV for rental purposes, then the *Towable Limited Warranty* will not apply to this RV. The *Towable Limited Rental Warranty* applies in that situation.

If, on the other hand, the Jayco dealer sells this RV to a retail customer then the rental warranty would not be applicable. **The rental warranty does not apply to retail consumers.**

Jayco's rental program is applicable to the following product lines:

- Jay Sport Camping Trailers
- Hummingbird Travel Trailers
- Jay Feather Travel Trailers
- Jay Feather 7 Travel Trailers
- White Hawk Travel Trailers
- Jay Flight Travel Trailers
- Jay Flight SLX Travel Trailers
- Eagle Travel Trailers
- Eagle Fifth Wheels
- Eagle HT Fifth Wheels
- Eagle HT Travel Trailers
- Designer Fifth Wheels
- North Point Fifth Wheels
- Pinnacle Fifth Wheels
- Octane Toy Haulers
- Seismic Fifth Wheel Toy Haulers
- Talon Fifth Wheel Toy Haulers

If you have any questions regarding this, please contact Jayco Customer Service at (800) 283-8267 or (574) 825-0608.

JAYCO TOWABLE RENTAL LIMITED WARRANTY

WHAT AND WHO IS COVERED:

The Jayco warranty covers this recreational vehicle ("RV"), when used only for recreational travel and camping, including recreational travel and camping by renters of the Dealer, for one (1) year. This limited warranty applies to the original Dealer only, and it is not transferable. The warranty period begins on the date that Dealer first places the RV in rental service. In the event that a substantial defect in material or workmanship, attributable to Jayco, is found to exist during the warranty period, Jayco will reimburse the Dealer either the reasonable costs of repair or the reasonable costs of replacement of the defect, (Jayco's option), in accordance with the terms, conditions and limitations of this limited warranty.

Jayco's obligation to reimburse Dealer for the reasonable costs of repair or replacement of defective materials or workmanship is the sole obligation of Jayco under this limited warranty. Jayco reserves the right to use new or remanufactured parts of similar quality to complete any work, and to make parts and design changes from time to time without notice to anyone. Jayco reserves the right to make changes in the design or material or its products without incurring any obligation to incorporate such changes in any product previously manufactured. Jayco makes no warranty as to the future performance of this RV, and this limited warranty is not intended to extend to the future performance of this RV, or any of

SECTION 1: WARRANTY & SERVICE

its materials, components or parts. In addition, the Dealer's obligation to notify Jayco, of a claimed defect does not modify any obligation placed on the Dealer to contact Jayco directly when attempting to pursue remedies under state or federal law.

LIMITATIONS, EXCLUSIONS AND DISCLAIMER OF IMPLIED WARRANTIES: ANY IMPLIED WARRANTY THAT IS FOUND TO ARISE BY WAY OF STATE OR FEDERAL LAW, INCLUDING ANY IMPLIED WARRANTY OF MERCHANTABILITY OR ANY IMPLIED WARRANTY OF FITNESS, IS LIMITED IN DURATION TO THE DURATION OF THIS LIMITED WARRANTY AND IS LIMITED IN SCOPE OF COVERAGE TO THE SCOPE OF COVERAGE OF THIS LIMITED WARRANTY.

Jayco makes no warranty of any nature beyond that contained in this limited warranty. Jayco does not authorize any person to create any other obligation or liability for it regarding this RV, and Jayco is not responsible for representation, promise or warranty made by any dealer or other person beyond what is expressly stated in this limited warranty, and no one has the authority to enlarge, amend or modify this limited warranty. Any selling or servicing dealer is not Jayco's agent, but an independent entity.

JAYCO SHALL NOT BE LIABLE FOR ANY INCIDENTAL OR CONSEQUENTIAL DAMAGES THAT MAY RESULT FROM BREACH OF THIS LIMITED WARRANTY OR ANY IMPLIED WARRANTY. THIS EXCLUSION OF CONSEQUENTIAL AND INCIDENTAL DAMAGES SHALL BE INDEPENDENT OF ANY FAILURE OF THE ESSENTIAL PURPOSE OF ANY WARRANTY, AND THIS EXCLUSION SHALL SURVIVE ANY DETERMINATION THAT THIS LIMITED WARRANTY OR ANY IMPLIED WARRANTY HAS FAILED OF ITS ESSENTIAL PURPOSE.

Some states do not allow limitations on how long an implied warranty lasts, or the exclusion or limitation of incidental or consequential damages, so the above limitations or exclusions may not apply to you.

HOW TO GET SERVICE:

To obtain reimbursement of warranty service the owner must do all of the following:

Notify Jayco of the substantial defect in material or workmanship attributable to Jayco, within the warranty coverage period.

1. Provide the notification mentioned in (1), above, within ten (10) days of when the owner discovered, or should have discovered, the substantial defect in material or workmanship attributable to Jayco;
2. Promptly and appropriately make the necessary repairs; and
3. Pay any freight or transportation costs, import duties, fees and all incidental expenses associated with obtaining warranty service.

If you need assistance you may contact Jayco, at 903 S. Main Street, P. O. Box 460, Middlebury, Indiana, 46540, Attn: Customer Service (574) 825-5861, (800) 283-8267 or www.jayco.com. Also, you must notify Jayco within three (3) days of delivery to you to have work performed on any defect or damage to appearance items that occurred at the factory during manufacturer or during delivery at no cost to you as provided by this limited warranty. (See below under WHAT IS NOT COVERED).

If two (2) or more service attempts have been made to correct any covered defect that you believe impairs the value, use or safety of the RV, or if it has taken longer than thirty (30)

SECTION 1: WARRANTY & SERVICE

days for those types of repairs to be completed, you must, to the extent permitted by law, notify Jayco directly, in writing, at the above address, of the unsuccessful repair(s) of the alleged defect(s) so that Jayco can become directly involved in making sure that you are provided service pursuant to the terms of this limited warranty.

WHAT IS NOT COVERED:

By way of example, only, this Limited Warranty does not cover any of the

following: defects in materials, components or parts of the RV not attributable to Jayco; items that are added or changed after the RV leaves the possession of Jayco; additional equipment or accessories installed at any dealership, or other place of business, or by any other party, other than Jayco; any RV not used solely for recreational travel and camping; excess weight placed on the Structural Components; all soft goods, normal wear, tear or usage, such as tears, punctures, soiling, mildew, fading, or discoloration of exterior plastic, fiberglass, upholstery, drapes, carpet, vinyl, screens, cushions, mattresses and fabrics; the effects of condensation or moisture from condensation inside the RV and failure to provide adequate ventilation; mold or any damage caused by mold to the inside or outside of the RV; imperfections that do not affect the suitability of the RV for its intended purpose of recreational use or items that are working as designed but that you are unhappy with; exterior paint or finish which is warranted independently by the paint manufacturer and/or independent applicator; problems related to misuse, mishandling, neglect or abuse, including failure to maintain the RV in accordance with the owner's manual, or other routine maintenance such as inspections, lubricating, adjustments, tightening of screws, tightening of lug nuts, sealing, rotating tires; damage due to accident, whether or not foreseeable, including any acts of weather or damage or corrosion due to the environment, theft, vandalism, fire, or other intervening acts not attributable to Jayco; damage caused by unregulated water pressure, tank over fill, or plumbing system modifications resulting in flooding of the vehicle; damage caused by unprotected electrical hook-ups (home or campground), power surges, lightning, circuit overload, or electrical system modifications; service items such as, lubricants, fluids, filters, etc.; damage resulting from tire wear or tire failure; defacing, scratches, dents, chips on any surface or fabric of the RV; wheel alignment or adjustments to axles when caused by improper maintenance, loading or damage from road hazards, including off road travel, wheel damage or balancing or damage from tire failures; damage caused by infestation by insects or other animals; damage caused by off road use, overloading the RV or alteration of the RV, or any of its components or parts.

In addition, this limited warranty does not cover any material, component or part of the RV that is warranted by another entity, including, by way of example, handling, braking, wheel balance, muffler, tires, tubes, batteries, gauges, generator, hydraulic jacks, inverter, converter, microwave, television, DVD/CD player, radio, speakers, television, refrigerator, range, hot water heater, water pump, stove, carbon monoxide detector, smoke detector, propane detector, furnace or any air conditioner. (Note: the written warranty provided by the manufacturer of the component part is the direct responsibility of that manufacturer).

Defects and/or damage to interior and exterior surfaces, trim, upholstery and other appearance items may occur at the factory or during delivery of the RV to you. These items are usually detected and corrected at the factory. You must inspect the RV for this type of damage when you take delivery from Jayco. If you find any such defect or damage you must notify Jayco within three (3) days of delivery of the RV to you to have these items covered by this limited warranty and to have work performed on the items covered by this limited warranty.

EVENTS DISCHARGING JAYCO FROM OBLIGATION UNDER WARRANTY:

Certain things completely discharge Jayco from any obligation under this warranty and void it. By way of example, the following shall discharge Jayco from any express or implied warranty obligation to repair or replace any defect that results from: any defect in a separately manufactured component part, any neglect or failure to provide routine maintenance by you or anyone you rent the RV to (See Owner's Manual), unauthorized alteration, off road use, collision or accident, whether or not foreseeable, including any acts of weather or damage or corrosion due to the environment, theft, vandalism, fire, explosions, overloading in excess of weight ratings, and tampering with any portion of the RV.

LEGAL REMEDIES:

Any action to enforce any portion of this limited warranty, or any implied warranty, shall be commenced within six (6) months after expiration of the warranty coverage period designated above. Any performance of repairs shall not suspend this limitation period from expiring. Any performance of repairs after the warranty coverage period has expired, or performance of repairs regarding anything excluded from coverage under this limited warranty shall be considered "good will" repairs, and they will not alter the express terms of this limited warranty, or extend the warranty coverage period or this limitation period. In addition, this warranty is not intended to extend to future performance, and nothing in this warranty, or any action of Jayco, or any agent of Jayco, shall be interpreted as an extension of the warranty or this limitation period. Some states do not allow a reduction in the statute of limitations, so this reduction may not apply to you.

WARRANTY REGISTRATIONS:

Your warranty registration records should be completed and delivered to the manufacturers of component parts. The Jayco product warranty registration form must be returned to Jayco within ten (10) days of your taking delivery of the RV. Your Jayco warranty will not be registered unless this warranty registration is completed and received by Jayco. Failure to file this warranty registration with Jayco will not affect your rights under this limited warranty as long as you can present proof of purchase, but it can cause delays in obtaining the benefits of this limited warranty, and it may inhibit any servicing facilities' ability to provide proper repairs and/or part replacement.

CARE AND MAINTENANCE:

It is your responsibility to perform proper care and maintenance of the RV, and to assure correct load distribution. For details regarding this, please see your Jayco owner's manual and other component part manufacturers. These outline various care and maintenance that is required to maintain your RV. Please review all manuals supplied with the RV, and contact Jayco or the supplier of the component part if you have questions. Note: failure to maintain the RV as noted in those manuals voids this limited warranty, and any damage to the RV as a result of your failure to perform such care, is not covered by this limited warranty.

THIS WARRANTY GIVES YOU SPECIFIC LEGAL RIGHTS, AND YOU MAY ALSO HAVE OTHER RIGHTS THAT VARY FROM STATE TO STATE.

JAYCO, INC.

903 S. Main Street * P.O. Box 460 * Middlebury, IN 46540

Telephone: 574-825-5861 or 800-283-8267

SECTION 1: WARRANTY & SERVICE

Notes:

SECONDARY MEANS OF ESCAPE (EXIT WINDOW)

Your recreation vehicle has been equipped with a window(s) that serves as a secondary means of escape. The window(s) will allow a quick exit from the vehicle during an emergency if access to the main entrance door is not available. It is easily identified by the red latches and label.

Do not remove the following label from your recreation vehicle:



Exit Window Label

When parking your recreation vehicle, make sure the egress window is not blocked by trees or other obstacles. Make sure the ground below the window is solid and can be used as an escape path.

Practice opening the window before an emergency occurs, and make sure all occupants know how to operate it.

The egress window(s) must be locked during transit.

Your recreation vehicle may be equipped with one of the following exit window styles:

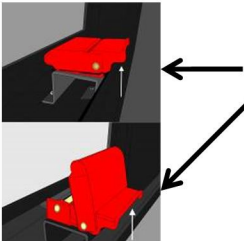

Flip latch style (2 per window)

Push up on the front lip of the latch and the latch unfolds.

Push up on the front lip of the latch again to unhook the latch from the window.

When both latches are released, push out on the window which is hinged at the top. Exit the vehicle.

The screen does not need to be removed from the window.

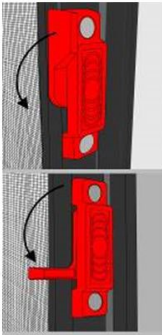

Slider window latch style

Pull the lever down to unlock the window. Slide the window to the right to open and exit the vehicle. The screen does not need to be removed from the window.

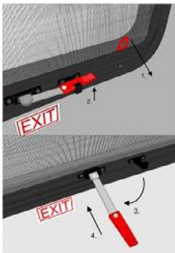

Lever style latch

Remove the screen by pulling the red tab (upper right arrow).

Pull the lever out from the sash clamps.

Swing the lever out so it is positioned straight out from the window. Push the lever (and window) out to open and exit the vehicle.

SECTION 2: OCCUPANT SAFETY

FIRE SAFETY

If a fire does start, follow these basic safety rules:

1. Call 911 and evacuate the vehicle immediately.
2. After everyone is accounted for, check the fire to see if you can attempt to put it out.
3. If it is large, or the fire is fuel-fed, get clear of the vehicle and have the Fire Department handle the emergency.
4. Do not attempt to use water to put out the fire. Water can spread some types of fire, and electrocution is possible with an electrical fire.

Refer to the following sections for additional fire safety information.

- Electrical Systems**, In case of an electrical fire.
- Appliances**, In case of a grease fire.

FIRE EXTINGUISHER

Fire extinguishers are classified and rated by fire type, A, B and C. These classifications identify the kinds of fires or burning materials they are designed to fight.

Class A - Solid materials such as wood, paper, cloth, rubber and some plastics.

Class B - Liquids such as grease, cooking oils, gasoline, kerosene or other flammable liquids.

Class C - Electrical such as electrical wires or other live electrical equipment.

A dry chemical fire extinguisher has been installed by the entrance door. It is suitable for extinguishing small fires of the Class B or C type only.

We suggest you become thoroughly familiar with the operating instructions displayed on the side of the fire extinguisher.



NOTE: For information on how to use your fire extinguisher, refer to the fire extinguisher user's manual

Inspection and maintenance

Read and follow all instructions on the label and user's manual provided by the fire extinguisher manufacturer.

- Inspect the extinguisher at least once a week (more frequently if it is exposed to weather or possible tampering). This should also be done before beginning a vacation or during an extended trip.

⚠ WARNING

Do not check the pressure, test or practice using the fire extinguisher by squeezing the trigger, even briefly. The fire extinguisher is not rechargeable or refillable. Once used, it will gradually lose pressure and will not be fully charged for use in an emergency.

⚠ DANGER

Do not turn the electrical power back on or plug in any appliances after the use of a fire extinguisher. Please refer to the fire extinguisher's user manual for further instructions on maintenance and clean up.

SMOKE ALARM

The smoke alarm will only work properly if it is operational and maintained. They have a limited life and will wear out over time. Immediately replace the detector if it is not working properly, if it displays any type of problem, or within five years of use. **Be sure to read, understand and follow the information provided by the smoke alarm manufacturer, including information on the limited life of smoke alarms.**

Be aware the smoke alarm **is not fool proof and cannot detect fires if smoke does not reach it**. Anything preventing smoke from reaching the alarm may delay or prevent an alarm.

Though the alarm horn in this detector meets or exceeds current UL standards, it may not be heard for reasons that include (but not limited to): a closed or partially closed door, other noise from electronics, appliances or traffic.

⚠ WARNING

- This smoke alarm will not alert hearing impaired residents. Special alarms with flashing strobe lights are recommended for the hearing impaired
- Only use the replacement battery recommended by the smoke detector manufacturer. The smoke detector alarm may not operate properly with other batteries. Never use a rechargeable battery as it may not provide a constant charge. Never disconnect the battery to silence the alarm.
- Test the smoke alarm operation after the vehicle has been in storage, before each trip and at least once per week during use. Do not disconnect the battery or the alarm.

The smoke alarm is operational once the battery is correctly installed. It will not function if the battery is missing, disconnected, dead, the wrong type or not installed correctly. **It requires one standard 9V battery.** Refer to the user's guide, for correct battery and installation information,

The LED light will indicate the battery is functioning properly. When the production of combustion is sensed, the smoke detector sounds a loud alarm that continues until the air is cleared. The LED light will also give a visual indication of a sounding alarm.

When the battery becomes weak, the alarm will “beep” about once a minute indicating a low battery. This warning should last for 30 days. You **MUST** replace the battery once the alarms low battery warning (beep) starts to assure continued protection.

When the battery is removed from the alarm, the battery flag will pop up; the alarm cannot be installed to the mounting bracket without a battery.

SECTION 2: OCCUPANT SAFETY

To test, stand at arm's length from the smoke alarm as the alarm horn is loud and may be harmful to your hearing. The test button will accurately test all functions. Never use an open flame to test the smoke alarm.

Do not remove the warning label located near the smoke alarm from your recreation vehicle:

Maintenance

Vacuum off any dust on the cover of the smoke alarm using a soft brush attachment. Test the smoke alarm once you have vacuumed. Never use water, cleaners or solvents to clean the smoke alarm as they may damage the alarm. Do not paint the smoke alarm. Refer to the manufacturer's use guide for detailed maintenance information.

▲ WARNING
Test smoke alarm operation after vehicle has been in storage, before each trip, and at least once per week during use. Failure to do so can result in death or serious injury.
▲ AVERTISSEMENT
VÉRIFIER LE DÉTECTEUR DE FUMÉE SI LE VÉHICULE A ÉTÉ ENTREPOSÉ, AVANT CHAQUE DÉPLACEMENT ET AU MOINS UNE FOIS PAR SEMAINE EN SERVICE.

COMBINATION CARBON MONOXIDE / PROPANE ALARM

Your recreation vehicle is equipped with a combination carbon monoxide (CO) / propane alarm that is listed for use in recreation vehicles. The combination carbon monoxide/propane alarm will only work if it is operational and maintained.

▲ WARNING

- The carbon monoxide detector installed is intended for use in ordinary indoor locations of recreation vehicles. It is not designed to comply with Occupational Safety and Health Administration (OSHA) commercial or industrial standards.
- Do not disconnect the battery or the alarm.**
- Individuals with medical problems may consider using warning devices that provide audible and visual signals for carbon monoxide concentrations under 30 PPM.
- This alarm will only indicate the presence of carbon monoxide gas at the sensor. Carbon monoxide gas may be present in other areas.
- The ultimate responsibility for protection against toxic carbon monoxide fumes rests solely on you.** Installing a carbon monoxide/propane alarm is just the first step in protecting your family from toxic carbon monoxide poisoning. **The following symptoms are related to carbon monoxide poisoning and** should be discussed with all members of the household:
 - Mild exposure:** Slight headache, nausea, vomiting, fatigue (often described as “flu-like” symptoms).
 - Medium exposure:** Severe throbbing headaches, drowsiness, confusion, fast heart rate.
 - Extreme exposure:** Unconsciousness, convulsions, cardio-respiratory failure, death.

The alarm is directly wired to the 12-volt electrical system, with continuous power being supplied by the recreational vehicle batteries. There is no 9-volt battery power supply. As a result, the alarm is always drawing a small amount of current from the recreation vehicle batteries. Although the current draw is slight, it could drain the batteries during extended storage periods. This condition is not likely to occur except during storage situations when the inverter cannot restore the battery charge. **If the battery cable is disconnected at the battery terminals, the combination alarm will not work.**

Be sure to read, understand and follow the owner's information from the manufacturer of the combination CO/propane alarm. This includes information regarding the limited life of the alarm. Carbon monoxide (CO) is an insidious poison. It is a colorless, odorless and tasteless gas. Many cases of reported carbon monoxide poisoning indicate while victims are aware they are not well, they become so disoriented they are unable to save themselves by either exiting the recreational vehicle or calling for assistance. Young children and household pets may be the first affected.

Your combination carbon monoxide/propane alarm is designed to detect the toxic carbon monoxide fumes that result from incomplete combustion, such as those emitted from appliances, furnaces, fireplaces and auto exhaust.

A carbon monoxide/propane alarm is **NOT A SUBSTITUTE** for other combustible gas, fire or smoke alarms. This carbon monoxide alarm is designed to detect carbon monoxide gas from ANY source of combustion. It is not designed to detect smoke, fire or any other gas. Please note that there are hazards against which carbon monoxide detection may not be effective, such as natural gas leaks or explosions.

This alarm is designed to sense the presence of carbon monoxide/propane gas, however there are other combustible fumes or vapors that may be detected by the sensor including (but not limited to): acetone, alcohol, butane and gasoline.

These chemicals can be found in commonly used items such as deodorants, colognes, perfumes, adhesives, lacquer, kerosene, glues, wine, liquor, most cleaning agents and the propellants of aerosol cans.

High temperatures can activate glue and adhesive vapors. If you close up a recreational vehicle on a hot day, the chemicals used in its construction may be detected for months after the vehicle was constructed (for more information, refer to Sec. 2, Formaldehyde).

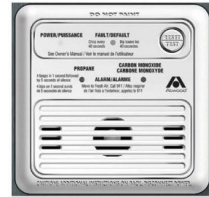

Carbon monoxide/propane alarm (alarm may vary from model(s) shown)

SECTION 2: OCCUPANT SAFETY

What you should do if the alarm sounds

WARNING

- Actuation of this detector indicates the presence of carbon monoxide which can kill you.
- Never turn the 12-volt battery disconnect control to the off position and disconnect the battery cable to silence an alarm. The alarm will automatically sense when the level of carbon monoxide in the air reaches below dangerous levels. You should stay outside the vehicle in fresh air until the alarm is silenced. When the alarm sounds, do not stand too close to the alarm. The sound produced by the alarm is loud because it is designed to wake a person in an emergency. Prolonged exposure to the alarm at a close distance may be harmful to your hearing.

1. Operate the RESET/SILENCE button.
2. Call your emergency services (fire department or 911).
3. Immediately move to fresh air (outdoors or by an open door or window).
4. Do not re-enter the premises or move away from the open door or window until the emergency service responders have arrived, the premises have been aired out, and your alarm remains in its normal condition.

If your alarm reactivates within a 24 hour period, repeat steps 1-4 and call a qualified appliance technician to investigate for sources of carbon monoxide from fuel burning equipment and appliances, and inspect for proper operation of this equipment. Make sure that motor vehicle(s) are not, and have not been, operating in an attached garage or adjacent to the recreation vehicle.

If problems are identified during this inspection, have the alarm serviced immediately. Note any combustion equipment not inspected by the technician and consult the manufacturer's instructions or contact the manufacturer directly for more information about carbon monoxide safety and this alarm.

Alarm signals

- Normal operation:** The LED will maintain a steady green light, indicating that the alarm is powered.
- CO alarm condition:** The red LED light will remain steady and the alarm will sound 4 "BEEPS" then silent for 5 seconds. These signals indicate immediate action is required.
- Propane gas alarm:** The red LED flash and the alarm will sound a steady tone. These signals indicate immediate action is required.
- Alarm malfunction/low battery:** The gas LED will remain off and the Operational/CO LED will alternate red/green and the alarm will sound once every 15 seconds.
- End of life alarm:** The LED will flash red/red, green/green and the alarm will "BEEP" every 25-30 seconds. The alarm should be immediately replaced.

Maintenance

Vacuum the alarm cover at least once a year. Clean the cover by hand using a cloth dampened in clean water. Dry with a soft cloth. Do not spray the front panel of the alarm with cleaning agents or waxes. This action may damage the sensor causing an alarm or cause the alarm to malfunction. Do not paint the face of the alarm.

Testing the combination carbon monoxide/propane alarm

WARNING

Test the alarm operation after the RV has been in storage, before each trip and at least once per week during use.

The TEST/RESET button tests all ELECTRICAL functions of the alarm. The TEST/Mute switch is located on the front of the alarm. Press and hold the test button for 1 second. The alarm is working properly if the GREEN indicator light changes color to RED and the horn beeps 4 times. The Gas LED should also blink red.



NOTE: Pressing the test button does not check the sensor operation. Refer to the carbon monoxide/propane alarm manufacturers user's manual provided with your recreation vehicle for additional information on testing the sensors.

Repair or replace the combination carbon monoxide/propane alarm when the alarm no longer functions. As with any electronic product, it has a limited life. Alarms that do not work cannot protect you.



NOTE: The carbon monoxide/propane alarm manufacturer strongly recommends replacement of the detector five years after the date of purchase.

FORMALDEHYDE

Some components in the recreation vehicle contain formaldehyde-based adhesives that may release formaldehyde fumes into the air for an unknown period of time. Individuals who are allergic to formaldehyde gas fumes may experience irritation to eyes, ears, nose and throat. Indoor air quality may also be affected by leaving your vehicle closed for a period of time.

To aid in dissipation, ventilate the recreation vehicle by opening all windows and circulate the air with a fan.

This label is located inside the vehicle near the entry door. The label should be left permanently affixed to the recreation vehicle:

CAUTION

Product in this vehicle may contain formaldehyde, which may be an irritant to you. You may experience a greater concentration during high humidity and temperatures. Ventilate to remove. Consult your owner's manual for additional information.

DO NOT REMOVE THIS LABEL

EXTENDED OR FULL TIME USAGE

Your new recreation vehicle has been built for enjoyment in a recreational manner. It is not intended for use as full-time quarters or a permanent residence. Continuous living in your vehicle could cause accelerated wear and damage to the various components.



CAUTION

Continuous or permanent living in your recreation vehicle may affect your warranty coverage and may void the “Limited Warranty” applicable to your vehicle.

COLD WEATHER USAGE

When used in freezing or below freezing temperatures, the precautions should be taken:

- Fresh water and drainage systems - preparations to avoid freeze-ups.
- Propane gas (if so equipped) and sufficient power is needed for protection from possible freeze-ups on the propane gas regulator. Keep in mind that more frequent furnace operation will substantially increase battery draw and propane gas use.
- During cool weather usage, ventilation or addition of a dehumidifier may be required to reduce condensation.
- Check outside extrusions on compartment doors, locks, slide outs, windows, vents, etc., for frozen moisture before operating to avoid damage to parts.

CONDENSATION



WARNING

Condensation may cause dampness, mildew, mold, staining and, if allowed to continue, it may result in damage to the recreation vehicle (damage caused by condensation is not warrantable). It can also lead to mold or mildew issues, which could be a health hazard.

Condensation is a natural phenomenon. The amount of condensation will vary with climate conditions, particularly the relative humidity. Condensation occurs because there is water vapor present in the air. When the temperature reaches the “dew point” the water vapor in the air condenses and changes to a liquid form.

Proper ventilation or the use of a dehumidifier (customer supplied) will assist in controlling the condensation. Suggestions to eliminate warm moist air:

- Crack open windows and roof vents to allow warm moist air to escape.
- Open the bath roof vent (if so equipped) approximately ½” when showering.
- Use the range hood fan (if so equipped) when cooking or washing dishes.
- Avoid hanging wet towels (or clothes) inside the recreation vehicle to dry.
- If found in cabinets or closets, open the doors slightly to provide ventilation.

TOW VEHICLE

If you plan to tow your recreation vehicle with a tow vehicle you already own, or if you plan to purchase a new one, make sure the Gross Vehicle Weight Rating (GVWR) or your recreation vehicle does not exceed your tow vehicles towing rating.

Ask your automotive dealer how to obtain a copy of information that deals with towing considerations, with or without an optional vehicle tow package.

VEHICLE LABELS

Decals and data plates used throughout the recreation vehicle aid in its safe and efficient operation; others give service instructions. Read all decals, data and instruction plates before operating your recreation vehicle. Any decal, data or instruction plate painted over, damaged or removed should be replaced.

Keep a record of the 17-digit chassis vehicle identification number (VIN), the 8-digit serial number, and your license number in the event theft or vandalism requires you to supply this information to the authorities.

WARNING

- The factory-installed weight labels are specific to the recreation vehicle for which they are supplied and are not interchangeable. Do not remove these labels from your vehicle. If labels are missing contact your dealer or Customer Service for replacements.
- Do not exceed any applicable weight ratings. Doing so could damage your RV or tow vehicle and adversely affect handling and braking characteristics.**

Weight Terms

GAWR - Gross Axle Weight Rating: The value specified by the vehicle manufacturer as the load-carrying capacity of a single axle system, as measured at the tire-to-ground interfaces. This is the total weight a given axle is capable of carrying.

GCWR - Gross Combined Weight Rating: The value specified by the trailer manufacturer as the maximum allowable loaded weight of the trailer including full propane cylinders, a full load of water, and full generator fuel if applicable.

GVWR - Gross Vehicle Weight Rating: The value specified by the manufacturer as the maximum permissible weight of the fully loaded trailer.

OCCC - Occupant And Cargo Carrying Capacity: Is equal to the GVWR of the trailer, minus the weight of the trailer (as completed at the factory) minus the weight of all personal cargo, and, if applicable, minus the weight of a full tank (or tanks) of propane and the full weight of potable water, including the water heater (if so equipped). Additions to or other changes made to the trailer after it left the factory will affect (reduce) the OCCC.

UVW - Unloaded Vehicle Weight: The weight of the trailer as manufactured at the factory with the weight of a full tank (or tanks) of propane.

Weight and Capacity Labels

The following labels are typically located on the roadside front corner of the RV. An additional Occupant & Cargo Carrying Capacity label is also located on the inward surface of the entry door.

SECTION 3: PRE-TRAVEL INFORMATION

OCCE Label (Occupant & Cargo Carrying Capacity):

The upper portion of this yellow label is federally required and includes the maximum Occupant & Cargo Carrying Capacity that may be placed in or on the trailer as it was manufactured and weighed before leaving the factory. This maximum capacity would not include the weight of a full fresh water tank. The full load of water weight would need to be subtracted from the maximum cargo weight. Additions or other changes made to the trailer after it leaves the factory will affect (reduce) the OCCE.

The lower portion of this label is provided voluntarily and indicates the weight value of the trailer as it was manufactured and weighed at the factory. It includes full propane tanks and full generator fuel (if so equipped).

RECREATION VEHICLE TRAILER CARGO CARRYING CAPACITY
VIN: XXXXXXXXXXXXXXXXX
THE WEIGHT OF CARGO SHOULD NEVER EXCEED:
545 kg. OR (1201 Lbs.)
CAUTION:
A FULL LOAD OF WATER EQUALS 166 kg. OR (365 Lbs.) OF
CARGO @ 1 kg/L (8.3 Lb/GAL)

THE WEIGHT OF THIS RECREATION VEHICLE TRAILER AS COMPLETED AT THE FACTORY WITH FULL PROPANE CYLINDER(S) AND FULL GENERATOR FUEL IF APPLICABLE IS:
2860 kg. OR (6299 Lbs.)

CONSULT YOUR DEALER AND SEE OWNER'S MANUAL FOR DEFINITIONS, ADDITIONAL WEIGHT, LOADING, WEIGHING INFORMATION AND TOWING GUIDELINES

OCCE Label (yellow)

NOTE: The total weight capacity of the tires on your RV can be less than the GVWR. The calculation for the actual weight on the RV tires does not include the tongue weight. The tongue weight is actually being carried by your tow vehicle, not the RV tires.

For example: If the tires are rated at 2,000 lbs. each x 4 tires = 8,000 lbs. and the RV has a GVWR of 9,000 lbs. with a tongue weight of 1,200 lbs. The actual weight on the RV tires is (9,000 – 1,200) which equals 7,800 lbs. which is within the weight rating of the tires.

The **Federal Certification Label** is required by the government to verify the trailer complies with all motor vehicle standards for Canada and the United States. It includes the following information: Manufacturer name, VIN, GVWR, GAWR (front/rear), tire & rim sizes and cold tire inflation pressures.

RESP. MFR: FABRICANT RESP: GVWR/PNW. KG	VJNJVJLV	08/11
9500 4517	SIZE/DIMENSION	PRESS./COLD INFL. PRESS./GONFL. FROID
GAWR/PNBE KG	TIRE/PNEU	PSI/LPC KPA
5000. 2270 FRONT/DEVANT	ST225/75R15D 15 X 6 JJ	65. 449
00000 INT/CENTRAL		0000.
5000. 2270 REAR/ARRIERE	ST225/75R15D 15 X 6 JJ	65. 0449
TYPE DE VEHICULE/TYPE DE VEHICULE: THIS VEHICLE CONFORMS TO ALL APPLICABLE U.S. FEDERAL MOTOR VEHICLE SAFETY STANDARDS AND STANDARDS PRESCRIBES UNDER THE CANADIAN MOTOR VEHICLE SAFETY REGULATIONS IN EFFECT ON THE DATE OF MANUFACTURE/TYPE DE VEHICULE: CE VEHICULE CONFORME A TOUTES LES NORMES DU CULI QUI S'APPLIQUENT EN VERTU DU REGLEMENT DU CANADA ET DES ETATS UNIS EN VIGUEUR A LA DATE DE SA FABRICATION C-10000A.		

Federal Certification Label

The **Tire and Loading Label** provides information on the tire sizes, cold tire inflation pressures, the VIN and maximum cargo capacity. The maximum cargo capacity listed on the label does not include the weight of a full load of water.

If you have further questions, please contact your dealer or our Customer Service department.

TIRE AND LOADING INFORMATION RENSEIGNEMENTS SUR LES PNEUS ET LE CHARGEMENT			
The weight of cargo should not exceed _____ kg or _____ lbs. Le poids de chargement ne doit jamais dépasser _____ kg ou _____ lbs.			
TIRE PNEU	SIZE DIMENSIONS	COLD TIRE PRESSURE PRESSION DES PNEUS A FROID	SEE OWNER'S MANUAL FOR ADDITIONAL REQUIREMENTS
FRONT DEVANT	ST225/75R15D	449 KPA, 65 PSI	YOUR OWNERS MANUAL FOR TOWING AND WEIGHT REQUIREMENTS
REAR ARRIERE	ST225/75R15D	449 KPA, 65 PSI	
DRIVE DE SECOURS	ST225/75R15D	449 KPA, 65 PSI	

Tire & Loading Information

LOADING YOUR RECREATION VEHICLE

⚠ WARNING

- ❑ **Never load the RV in excess of the GAWR for either axle. Overloading your RV may result in adverse handling characteristics and damage to the RV.**
- ❑ **DO NOT EXCEED YOUR GVWR!** This means you should weigh your RV as loaded for your normal travel to determine the actual weight. If you exceed the GVWR, you **MUST** remove items from the RV, or drain liquids, then re-weigh the vehicle to ensure you have achieved a safe weight. **Do not travel with full grey/black holding tanks.** This not only wastes gas but, depending upon the location of the grey or black holding tanks, can affect handling characteristics.

Store and secure all loose items inside the RV before traveling. Overlooked items can become dangerous projectiles during a sudden stop.

Distribute cargo side-to-side so the weight on each tire does not exceed one-half of the GAWR for either axle. Make sure any tie down straps (if so equipped) on appliances or furniture are secure. Load heavy objects on the floor, or as low as possible.

⚠ WARNING

- ❑ Your recreation vehicle's load capacity is designated by weight, not by volume, so you cannot necessarily use all available space when loading the vehicle. Do not exceed your GVWR and ensure you are loading the vehicle as evenly as you can for the best possible handling. Ensure heavy items are secured so they do not shift during travel.
- ❑ Store items in areas designated for storage. **Do not store anything in the areas reserved for the converter, electrical panels or the furnace or water heater, etc.**

CARGO CARRYING ACCESSORY RECEIVER (IF SO EQUIPPED)

⚠ WARNING

Receiver is for cargo carrying accessories ONLY. DO NOT tow any trailer or other vehicle. Load Limit for this receiver is 300 lbs Maximum. Use for towing or exceeding load limit will void the warranty. Failure to follow the instructions can cause the carrier to collapse or items to fall which could cause an accident resulting in death or serious injury.

SECTION 3: PRE-TRAVEL INFORMATION

REAR BUMPER

CAUTION

Do not add items to the recreation vehicle rear bumper. Add-on items will eventually damage your bumper. Damage caused by such aftermarket equipment installation or improper loading voids the **Towable Limited Warranty**.

The rear bumper of your RV is not designed to carry cargo. Items that extend beyond the bumper OR weigh over 100 lbs. (45kg) will place undue strain on the bumper. The 100 lb. bumper capacity includes the weight of the spare tire (if so equipped).



NOTE: Some items may fall within the given weight range, (IE: bike racks) however, they can still cause damage. In addition, extra weight behind the axle may reduce the hitch weight which can adversely affect handling.

TRAVEL TRAILER HITCH (CUSTOMER SUPPLIED)

Hitch selection affects the towing and handling characteristics of your recreation vehicle. There are many kinds of hitches available and assuring that you have the correct hitch installed is critical to a safe towing.

Ask your dealer about the proper class and type of hitch you need for your individual tow vehicle/RV combination. A travel trailer requires a frame mounted hitch.

The hitch class rating based on the capacity that hitch has for towing and a weight classification. The weight classification is determined from the hitch's weight carrying capacity (the tongue weight on a travel trailer). Before selecting a hitch, you must know your GVWR and tongue weight. **The rating of the hitch package purchased should be equal to or greater than the RV's GVWR and the hitch weight.**

CAUTION

Using an oversized or undersized hitch can cause damage to the RV frame. Jayco cannot be responsible for the tow vehicle suspension system. The final ball height after the tow vehicle/travel trailer combination is completely hooked up is a factor that must be considered. To avoid overloading your trailer axles and minimize possible handling difficulties, your trailer should be level when hooked to your tow vehicle. Do not overload your tow vehicle.

Equipment that sometimes gives autos, trucks and sport utility vehicles a softer ride can accentuate swaying when pulling a RV. Suspension that is too stiff will increase vibration, bounce and accelerate wear of your tow vehicle and RV combination.

Your recreation vehicle manufacturer cannot be responsible for the suspension system of any tow vehicle. There are a variety of tow vehicle suspension systems available that

will affect the ball height, stability and levelness of a hooked up RV. Make sure your dealer is aware of the tow vehicle you are using so a compatible hookup is achieved.

Travel Trailer Hitch Weight

Maintain the proper tongue weight of the trailer. Stay within the target range of 10%-15% of the overall gross weight (travel trailer weight plus contents).

Travel Trailer Hitch Height & Hitch Ball

This unit hitch height is:

To determine the hitch height for your model, make sure that the trailer is level. When the loaded RV is hitched to the tow vehicle, check the hitch ball height. This can be determined by measuring the distance from the center of the hitch ball to the ground. Record this number in the box for future reference.

Adjust the equalizing bars of the hitch assembly so that the tow vehicle and the trailer are essentially level. A high hitch will transfer weight behind the axles and cause the vehicle to fishtail. A low hitch will transfer additional weight to the hitch. Refer to the hitch manufacturer instructions to adjust the weight-distributing hitch to the proper height.

If you have additional questions, consult with your dealer. Make certain your Dealer is aware of the tow vehicle you are using so a compatible hookup is achieved. Depending on the model, your required travel trailer hitch ball diameter is either 2" or 2-5/16" (consult your dealer for assistance).

Travel Trailer Hitching Procedure

The following procedure will help to assist you in securely hooking up your recreation vehicle to your tow vehicle.

1. Make sure the trailer wheels are blocked.
2. Turn the tongue jack crank to raise the travel trailer tongue above the hitch ball.
3. Open the coupler latch on the travel trailer hitch.
4. Back the tow vehicle into the proper position.
5. Turn the tongue jack crank to lower the coupler onto the hitch ball.
6. Close the coupler latch after it is completely seated.
7. Install the (customer supplied) weight distributing bars (equalizers) as directed by the OEM.
8. Remove the dolly wheel or platform and retract the tongue jack to its maximum height.
9. Attach the breakaway switch cable to the tow vehicle.
10. Attach the safety chains.
11. Plug in your wire harness/connector plug from the tow vehicle to the travel trailer.
12. Walk around the RV to verify exterior lights are working correctly.
13. Remove the trailer wheel blocks.



NOTE: If an Atwood brake actuator is used with an equalizing hitch, be sure the hanger chains hang between straight down and forward up to 34°. Do not use less than 6-1/2" hanger chain length. For optimum brake performance, hang chains forward 34°. Refer to the manufacturer's owner's manual for more information.

SECTION 3: PRE-TRAVEL INFORMATION

Travel Trailer Weight Distributing System (customer supplied): This system provides a more stable tow vehicle/RV combination as it will spread the weight evenly to distribute it to the tow vehicle front and rear axles and the trailer axle. Consult with your dealer for information on requirements and operation of this system. Be certain your tow vehicle can carry the hitch weight.

Travel Trailer Sway Control (customer supplied): Sway control devices are available to reduce the sway produced by crosswinds, air displacement caused by other vehicles passing you in transit, incorrect weight distribution, excessive speed, the RV tires dropping onto the shoulder of the road, etc. The use of sway control will help to control the side-to-side movement and keep sway in check. Consult your dealer for additional information.

WARNING

A sway control device (customer supplied) should be used with your tow vehicle/travel trailer combination. Consult with your Dealer to obtain the proper equipment for your needs.

Suggestions for sway situations:

- Slowly ease your foot off the accelerator.
- Turn the steering wheel as little as possible. Natural lag time reaction when counter-steering to correct sway could possibly make it worse.
- If the trailer is equipped with electric brakes, using the hand control will help to keep the vehicles aligned.
- As soon as possible, stop to determine the cause of the sway. Check all equipment and load distribution. If the problem cannot be solved immediately, contact your dealer for a service appointment. Reduce your speed until the issue is resolved.

Travel Trailer Safety Chains: Your RV is equipped with chains to meet SAE standard requirements for maximum gross trailer weight.

Always have the safety chains attached when towing. Install them as shown below so they do not restrict sharp turns, but tight enough so they do not drag on the ground.

Crisscross the left safety chain under the coupler and attach to the right mounting slot in the trailer hitch; repeat with the right safety chain. Slack for each length should be the same but not more than necessary to permit the vehicle to turn at its minimum radius, but tight enough not to drag on the ground.

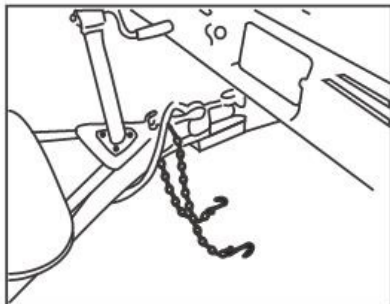

1. Inspect chains to determine if they are properly attached to trailer frame.

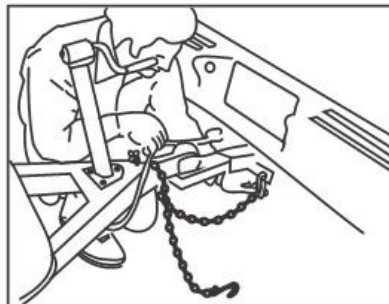

2. Criss-cross left chain and attach to right mounting slot in tow vehicle hitch.

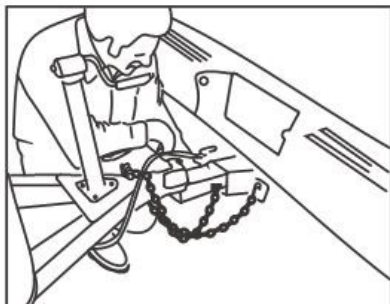

3. Repeat Step 2 with right chain. Slack for each length should be the same but not more than necessary to permit the vehicle to turn at the minimum radius.

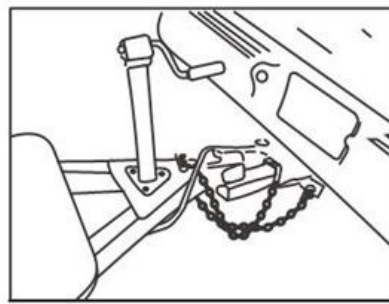

4. Properly mounted safety chains. Note that the jack is fully raised and dolly wheel removed.

Safety Chain Installation

WIRE HARNESS/CONNECTOR PLUG

A 7-way wire harness/connector plug is wired into your trailer to connect electrical power from the tow vehicle for travel. This supplies power to the RV brakes, taillights, clearance lights, turn signals, brake lights, etc. Wiring to operate your brakes must be the same size in both the tow vehicle and RV (the RV brake wiring is 12-gauge wire).

When attaching wires to your tow vehicle, tape all the connections for moisture protection.

White	1	Ground
Blue	2	Brakes
Green	3	Running lights
Black	4	Auxiliary battery charge line
Red	5	Stop & left turn
Brown	6	Stop & right turn
Yellow	7	Back up



7-Way Trailer Plug- car end rear view

The connector plug may build up corrosion with extended use and should be cleaned periodically to insure good electrical contact. Make sure the connector plug is kept clean and protected from road elements as you travel.

WEIGHING YOUR TOW VEHICLE & RV

When the RV is fully loaded it should be weighed. The actual weight of the vehicle, all options, liquids, the hitch weight, and your personal cargo is important for you to know so you do not exceed the GVWR. Two important factors when loading your RV are total weight and balance.

It is imperative that you verify compliance within all applicable weight ratings. Overloading your RV will void the **Towable Limited Warranty** and the warranties of many component part manufacturers.

Periodically weigh your RV at a public scale to determine proper load distribution. To obtain the side-to-side weights, there needs to be enough space on either side of the scale to accommodate the RV being partially off the scale. **Keep in mind that individual scales will operate differently.**

To weigh your tow vehicle and RV

⚠ WARNING

- Total weight of your tow vehicle and RV must not exceed the GCWR.** Do not assume that you can tow a RV that happens to be within the capacity of the tow vehicle hitch. By doing so, you may exceed the total GCWR of your tow vehicle and RV towing combination.
- It is important to redistribute the load to avoid component failure as well as to improve the handling characteristics of the vehicle and not void the **Towable Limited Warranty.**

Your RV must be weighed fully loaded (with food, clothing, fuel, water, propane, supplies, etc).

1. Weigh the RV including the tongue weight, while detached from the tow vehicle. This actual overall weight must be less than or equal to the GVWR for safe operation. If the overall weight is greater than the GVWR, some contents must be removed until the actual overall weight is less than or equal to GVWR.
2. Hitch the RV to your tow vehicle. Weigh the RV and the tow vehicle to determine the GCW. Make sure that this rating is less than or equal to the GCWR as specified by the manufacturer of your tow vehicle. If this overall weight is greater than the GCWR, some contents must be removed to bring the combination into compliance with the listed ratings.
3. Weigh the RV while attached to but excluding the tow vehicle. This will result in the actual weight that is exerted on all of the RV tires. This weight may be subtracted from the overall RV GVWR to determine the actual “tongue” weight.
4. With the RV still attached to the tow vehicle, weigh each wheel position separately to ensure each tire is not overloaded.

To determine the wheel position weight:

5. Pull the RV onto the scale so only one tire is on the scale. Record the weight. Your RV must remain as level as possible on the scale (even though an axle or side is not physically on the scale).

SECTION 3: PRE-TRAVEL INFORMATION

6. To calculate the opposite side of the RV wheel position weight, subtract the first side's weight from the weight determined in step #3.

If there is a difference in the weights on one side of the vehicle as compared to weights on the other side, components (tires, wheels, brakes, springs, etc.) on the heavier side could be overloaded, even though the total axle load is within the GAWR.

Once actual weights are obtained, compare them to the **Weight Information Label** weight ratings to ensure you are below the posted minimum ratings.

See the *Weight Terms* and *Loading Your RV* sections for important weight information.

SECTION 3: PRE-TRAVEL INFORMATION

Notes:

TOWING**⚠ WARNING**

- Your RV braking system is rated for operation at GVWR not GCWR.**
- Whenever possible, do not travel with waste in the holding tanks. Liquid or debris in the holding tank(s) may affect the towing characteristics and may result in property damage or personal injury.
- The propane cylinder(s) should be turned off when traveling. Most refrigerators will keep food cold or frozen for eight hours without running while you travel.

Your RV will travel safely and comfortably at highway speed limits. It will take longer than a passenger automobile to reach that speed. Allow more time to go around vehicles you are passing. Avoid situations that might require sudden momentum changes as the length of the tow vehicle/RV combination affects your ability to quickly cut back into traffic. Swerves and sharp turns, especially at high speeds, could result in loss of control of the tow vehicle/RV. Slow down in advance of dips, bumps and railroad tracks to reduce the jolting to your tow vehicle/RV combination. Proceed slowly and let the trailer tires pass over them before accelerating.

Adverse weather conditions and extremes in terrain may affect the performance and handling of your tow vehicle. Do not operate the tow vehicle cruise control on icy or extremely wet roads, winding roads, in heavy traffic or in any other traffic situation where a constant speed cannot be maintained.

When descending a long hill, drop down into a lower gear or range. Avoid conditions that require excessive and prolonged use of your brakes. Apply and release brakes at short intervals to allow them to cool. The tow vehicle transmission and engine will help in controlling downhill speed and can lengthen brake life. Use care when accelerating or decelerating on a slippery surface. Abrupt speed changes can cause skidding and loss of control.

Know the weight and size of your towing combination and observe any posted weight and clearance limits. The added height of roof air conditioners, TV antennas or floodlights may cause clearance problems around some tunnels, canopies and hanging signs.

When turning, the tires do not follow the path of your tow vehicle tires. The RV will make a tighter turn than the tow vehicle. Compensate for this action by carefully pulling the tow vehicle out into the intersection further than you would normally so that the RV clears the curb. When making a turn, check the road clearance and be aware of others. Swerves and sharp turns, especially at high speeds, could result in loss of control of the RV.

If your camping destination does not have pull through sites, pick a level site and back in carefully. Check to ensure there are no obstacles in your path and that you have plenty of vehicle clearance.

After the RV is in the desired location, set the tow vehicle parking brake. Block all RV wheels securely with wheel chocks to prevent it from rolling.

RV Brake System

Even though your RV is equipped with brakes designed for GVWR, proceed with caution until you become accustomed to your RV's stopping distance.

SECTION 4: VEHICLE OPERATION

Driving through water deep enough to wet the brakes may affect stopping distance or cause the vehicle to pull to one side. Check the RV's brake operation in a safe area to be sure they have not been affected. **Never operate any vehicle if a difference in braking efficiency is noticeable.**

Electric Brakes

WARNING

Failure to maintain the brakes in proper working condition as specified in the operator's manual supplied by the axle OEM will cause property damage, personal injury and possibly death. Consult with your dealer for assistance.

The electric brakes are designed to work with the tow vehicle brakes. To maintain proper braking performance, both the RV and tow vehicle brakes must be used together. Separate use of the braking systems will cause accelerated wear and damage.

When your RV is new, it is impossible to adjust the brake shoes precisely. It takes approximately 1,000 miles and/or 50 medium to heavy stops to "burnish" fit or "seat" the shoes to the brake drum. After the initial break-in period your brake shoes must be adjusted accurately for best performance and increased durability.

Braking system components include:

- Tow vehicle battery
- Brake controller
- Wire harness/connector plug
- Trailer battery
- Breakaway switch

The tow vehicle battery is the primary source of power for your RV's electric brake operation. To ensure available power when needed, keep your tow vehicle battery and charging system working properly.

Brake Controller (customer supplied)

The brake controller should be installed in the tow vehicle to work in conjunction with the RV electric brakes. Consult with your dealer or the brake controller OEM to decide what is right for your towing combination.

Travel Trailer Breakaway Switch

CAUTION

NEVER use the breakaway switch and trailer brake system as a parking brake. Doing so would create a high amp draw on the battery and converter. This can cause damage to wiring, connectors and the breakaway switch.

The breakaway switch is a crucial part of the RV braking system. Located on the travel trailer A-frame (or beside the fifth wheel pinbox), this switch will apply the trailer brakes if the trailer becomes detached from the tow vehicle. Attach the breakaway switch lanyard to a permanent part of the tow vehicle (on a travel trailer do not attach it to the hitch ball or similar removable parts) when hitching the trailer. If the RV becomes detached from the tow

vehicle, the pull pin will be pulled from the switch. This automatically causes the switch to “close” and activates the RV brakes. **A battery (customer supplied) must be installed to activate the breakaway switch.**

Hydraulic Brakes (if so equipped)

Your RV may be equipped with hydraulic surge brakes that operate automatically as the tow vehicle’s brakes are applied. When speed is decreased and brakes are applied, the weight of the trailer moving forward creates a reaction, which causes the brake fluid inside the wheel cylinder to activate the brake shoes against the drum.

As a result of this design, backing the RV uphill may activate the surge brake system making it difficult to continue in reverse. To aid in backing up the RV:

1. Prior to backing up a slope or through soft ground, pull the recreation vehicle forward slightly to assure that the actuator socket is in the forward position.
2. Move the lever on the side of the actuator downward from the “towing position” along the curved slot in the actuator frame to the “backup position.” The slot has a notch at the bottom of its travel. Push the lever down to engage the locking notch.
3. The RV will now back up. This lever will slide into the correct position when pulling forward.

It is extremely important to keep the master cylinder full at all times. An empty cylinder invites moisture.

Disc Brakes (if so equipped)

If your RV is equipped with disc brakes, see the manufacturer’s owner’s manual for detailed safety and maintenance information.

TOWING BEHIND YOUR RV

⚠ WARNING

If you do not have a **Jayco factory installed hitch receiver**, towing items behind your Jayco RV, or overloading the rear, will void the warranty and may result in: damage to the RV or add-on items, towing difficulties, property damage and/or personal injury.

NOTE: IF YOU DO NOT HAVE A JAYCO FACTORY INSTALLED HITCH RECEIVER, DO NOT TOW ANYTHING BEHIND YOUR RV. THE RV FRAME AND BUMPER ARE NOT DESIGNED FOR TOWING.

NOTE: A hitch equipped for trailer towing will have tabs to hang the safety chains and there will be a bracket for the trailer wiring plug. There should also be a label on the hitch stating maximum towing capacity.

SECTION 4: VEHICLE OPERATION

ENTRANCE DOOR STEP(S)

Make sure your entrance step is fully extended before exiting the vehicle, and retracted prior to towing.

Lubricating the step mechanism

Carefully clean the area around the pivot points (the rivets involved in the motion of the mechanism). Lubricate these pivot points with an automotive grade, non-staining lubricant every 30 to 60 days.

Wipe any excess lubricant off of the step and then clean the entire step after lubricating.

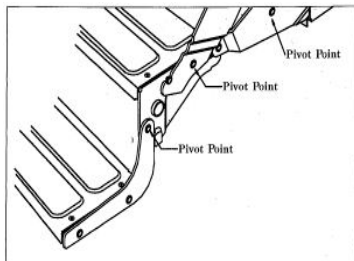

Step Light

Your RV may be equipped with a switch located on the skirt (in front of the steps) which operates a light located under the step assembly.

ENTRANCE DOOR

Always hold onto the entrance door when opening or closing it. Damage caused because you failed to do so is not covered by the **Limited Warranty**.



CAUTION

Make sure the entrance door is completely closed and locked when traveling. Locking the door helps prevent it from opening unintentionally and keeps intruders from your recreation vehicle.

The entrance screen door may be equipped with a slide panel that allows access to the entrance door handle and locks. The entrance door may also be equipped with both a regular door lock and a dead bolt lock.

Keys

Several keys are provided when you purchase your vehicle. Most keys have an individual key number stamped on the plate. Record these key numbers and keep the information in a safe place. You can order a key blank from your dealer to have duplicate keys made. If you lose the keys, contact your dealer or a locksmith for assistance.



NOTE: Locks on entrance and baggage doors need biannual lubrication using a light coat of silicone spray. Conditions such as rain, salt, dust and pollution may increase the maintenance needs.

REAR BACKUP CAMERA PREP

Your recreation vehicle has been pre-wired to allow for installation of a (customer supplied & customer installed) rear backup camera. Wiring is in place to install the camera at the rear of the vehicle, and has been routed to the master bedroom to allow a hookup for the camera monitor. This feature also allows you to use also use your camera as a security monitor.

Depending on your model, you may also have a pre-installed power switch for the camera located in an exterior compartment. (battery storage or utility center)

To install a backup camera, refer to the manufacturers installation guide along with the installation supplement provided in the warranty packet.

CAMPSITE HOOK-UP

- Refer to *Electrical Systems* section before connecting the shore line power cord (when using full hook-up) OR before starting the generator (if so equipped) or operating the vehicle on 12-volt power when dry camping.
- Refer to *Fuel & LP System section before using the LP system*. Open the LP gas tank valve (if so equipped) slowly. There may be air in the lines and five to thirty seconds of time is needed to bleed air before LP vapor fills the lines.
- Refer to *Plumbing Systems* section before connecting the fresh water supply or turning ON the water pump or water heater.
- When using full hook-up, connect the sewer hose to the campsite sewer hook-up.
- If applicable, start the refrigerator and the cooling or heating system.



NOTE: For extended dry camping, management of all your resources is essential. Check your battery levels and conserve battery power, use it sparingly

(BAL)LEVELING SYSTEM (IF SO EQUIPPED)

⚠ WARNING

- NEVER USE THIS SYSTEM FOR ANYTHING OTHER THAN ITS INTENDED USE.
- NEVER USE THE LEVELING SYSTEM AS A LIFT FOR CHANGING TIRES OR WORKING UNDER THE UNIT.
- KEEP PEOPLE, PETS AND OBSTRUCTIONS CLEAR OF THE UNIT BEFORE TURNING ON THE LEVELING SYSTEM AND WHILE OPERATING THE SYSTEM.
- DO NOT MOVE/TOW THE RV WITH THE JACKS EXTENDED.
- ALWAYS CHOCK THE TIRES BEFORE DISCONNECTING THE UNIT FROM THE TOW VEHICLE OR OPERATING THE LEVELING SYSTEM.
- PARK THE UNIT ON REASONABLY SOLID SURFACE SO JACKS DON'T SINK INTO THE GROUND. USE LOAD DISTRIBUTION PADS UNDER EACH PAD ON SOFT SURFACES.
- PARK THE UNIT ON REASONABLY LEVEL SURFACE. MAKE SURE THERE ARE NO OBSTRUCTIONS/DEPRESSIONS BEFORE OPERATING THE SYSTEM.
- MAKE SURE THE TOW VEHICLE IS DISCONNECTED AND MOVED CLEAR OF THE RV BEFORE STARTING THE LEVELING PROCESS.
- NEVER LIFT THE WHEELS OF THE UNIT COMPLETELY OFF THE GROUND TO LEVEL THE UNIT.
- CHECK TO ENSURE THE UNIT IS CONNECTED PROPERLY TO THE TOW VEHICLE BEFORE EXECUTING THE "TONGUE JACK RETRACT" FUNCTION.
- VISUALLY CHECK ALL JACKS TO ENSURE THAT THEY ARE FULLY RETRACTED BEFORE TOWING.
- READ OWNERS MANUAL BEFORE OPERATING.
- FAILURE TO HEED ANY OF THESE WARNINGS MAY RESULT IN DAMAGE TO THE UNIT, TOW VEHICLE, OR CAUSE SERIOUS INJURY OR DEATH.

The BAL Leveling System is both an automatic and a manual leveling system for a towable RV. The control screen and ON/OFF button is located in a lockable compartment on top of the power tongue jack.



Operation:

NOTE: At any time during an Auto function you may press the STOP button to abort Auto functions.

Buttons outlined in white are selectable.

Buttons outlined in yellow are active.

AUTOMATIC FUNCTIONS INCLUDE:

- RV Detachment
- Auto Leveling (front stabilizer jacks, and rear leveling legs)
- RV Attachment
- Tongue Jack Extend or Retract

MANUAL FUNCTIONS INCLUDE:

- Manual Leveling (Rear leveling legs)
- Manual Stabilizer Leveling (front stabilizers)
- Manual Tongue Jack Extend or Retract

NOTE: Instructions explaining the operation of these functions are too lengthy for inclusion in this manual. For specific leveling instructions please refer to the manufacturer's owner manual included in your warranty packet.

UNIT DETACHMENT AND AUTO LEVEL:

1. Lower the tongue jack adjustable foot, and chock wheels.
2. Press ON/OFF to activate display. (A below).
3. Press TONGUE JACK MODE (B below).
4. Press and hold EXTEND (C below) until the necessary detachment height is reached.
5. Disconnect the trailer and pull tow vehicle completely clear of the unit.
6. Lower the rear leveling jack adjustable feet and position them so that they are close to the same distance from the ground.

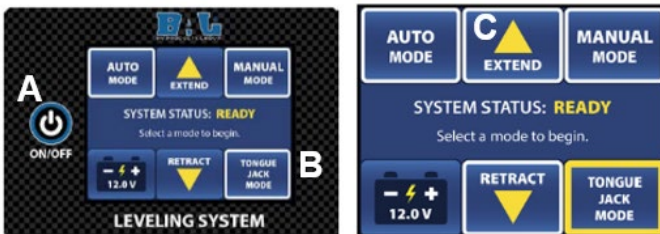

SECTION 4: VEHICLE OPERATION

7. Press AUTO MODE (D below).
8. Press AUTO LEVEL (E below).
9. Press OK (F below) to begin Auto Leveling or STOP to make another selection.

WARNING

Vehicle, people, pets and obstructions must be completely clear of the unit before executing the “Auto Level” function.



10. The system will go through a series of moving the jacks and checking the unit for level. The display will read “Auto Level in Progress”. (G below)
11. When the system successfully levels the unit the display will read “Auto Level Successful” and a beep will sound. (H below)

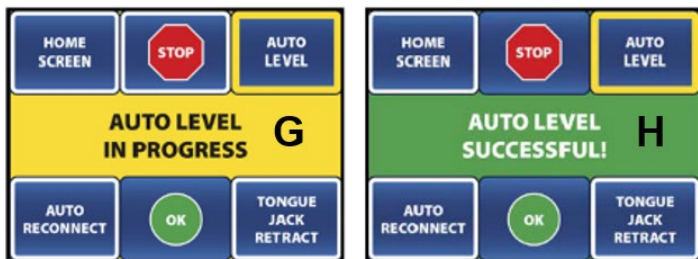

12. Press ON/OFF to deactivate the display.
13. Close and latch the cover of the touch screen display.

 **NOTE:** If the system fails to Successfully Auto Level, check the unevenness of the area underneath the unit. All lifting jacks must be able to make full contact for the system to function properly.

UNIT ATTACHMENT:

1. Press ON/OFF to activate the display. (J below)
2. Press AUTO MODE. (K below)
3. Press AUTO RECONNECT (L below)
4. Press OK to begin Auto Reconnect or STOP to make a new selection.

⚠ WARNING

Vehicle, people, pets and obstructions must be completely clear of the unit before executing the “Auto Level” function.

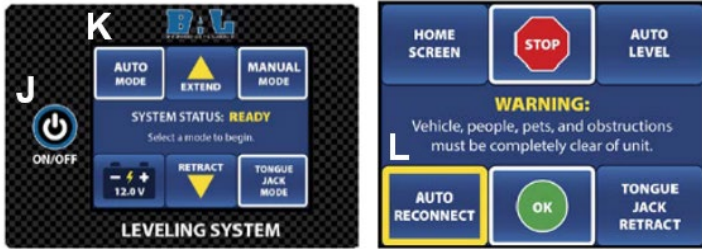

5. The system will retract all stabilizer jacks and the rear leveling jacks, then extend or retract the tongue jack until proper connection height is achieved. Display will read “Auto Reconnect in Progress”. (M below)
6. When the system has completed the “Auto Reconnect” function the display will read “Auto Reconnect Successful” and a beep will sound. (N below)

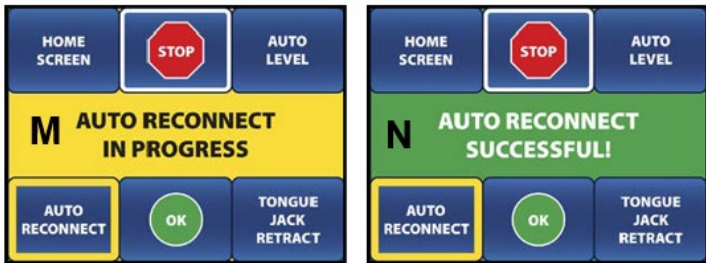

TONGUE JACK RETRACT:

1. TONGUE JACK RETRACT: Press HOME SCREEN. (O below)
2. Press and hold RETRACT (P below) until the unit can be connected to the tow vehicle.
3. Connect the unit to the tow vehicle.
4. Press AUTO MODE. (Q below)
5. Press TONGUE JACK RETRACT. (R below)



⚠ WARNING

Always check to ensure the unit is properly connected to the tow vehicle before retracting the tongue jack.

SECTION 4: VEHICLE OPERATION

- Press OK (S below) to begin “Tongue Jack Retract” or STOP to make a new selection. The display will read “Tongue Jack Retract in Progress”.
- When the jack has been fully retracted the display will read “Tongue Jack Retract Successful” (T below) and a beep will sound.
- Raise all adjustable feet to the hole that provides the most ground clearance before towing the unit.
- Press ON/OFF to deactivate the display.
- Close and latch the cover of the touch screen display.

⚠ WARNING

Always check to ensure the unit is properly connected to the tow vehicle before retracting the tongue jack.



MANUAL LEVELING JACK:

- Press MANUAL MODE. (U below) Use bubble level on the display to guide you. When the bubble is in the center of the circle the unit is level.
- Press and hold FRONT, REAR, LEFT or RIGHT and the jacks move as follows:
 - FRONT: Tongue jack on the front of the unit.
 - REAR: Both leveling jacks on the rear of the unit (closest to axles).

NOTE: Run the rear leveling jacks all the way to the ground before lifting side to side.

- LEFT: The left rear leveling jack (road side).
 - RIGHT: The right rear leveling jack (curb side).
- Press RETRACT (V below) and then press and hold FRONT, REAR, LEFT or RIGHT. The jacks will move in the same grouping as listed above.
 - Press ON/OFF to deactivate the display.
 - Close and latch the cover over the touch screen display.

⚠ WARNING

Fully retract stabilizers before retracting / extending leveling legs. Press and hold EXTEND/RETRACT to move stabilizers or select another mode.



MANUAL OVERRIDE PROCEDURE:

Tongue Jack Manual Override:

The electric tongue jack can be overridden and operated manually in the event of a malfunction. There are two methods to manually operate the tongue jack.

Method 1:

At the bottom of the tongue jack motor there is a round plastic plug. Remove the plastic plug to expose a 5/16" override hex adapter. Use a drill with a 5/16" socket and rotate hex adapter to operate the tongue jack.

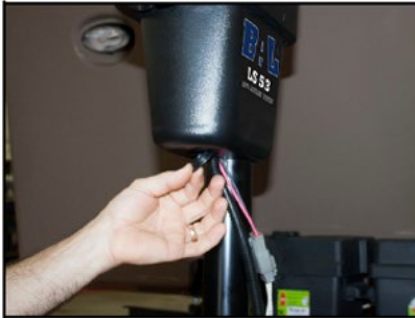

Method 2:

The tongue jack can also be overridden by removing the rubber plug to the right of the touch screen in the compartment on top of the tongue jack. Use a ratchet wrench and insert a 3/8" square drive extension into the square hole located inside the plastic cover.



Rear Leveling Jack Leg Override:

The rear leveling jack legs can be manually overridden as well. There is a plastic plug located on each leg motor. Remove the plastic plug to reveal a 5/16" hex adapter. Use an electric drill with a 5/16" socket to manually raise or lower each rear leg.



SECTION 4: VEHICLE OPERATION

Stabilizer Jack Manual Override:

Electric stabilizer jacks can be overridden manually also. To manually operate the stabilizer jacks, use a drill with a 3/4" socket and put it on the 3/4" nut on the end of the stabilizer jack.

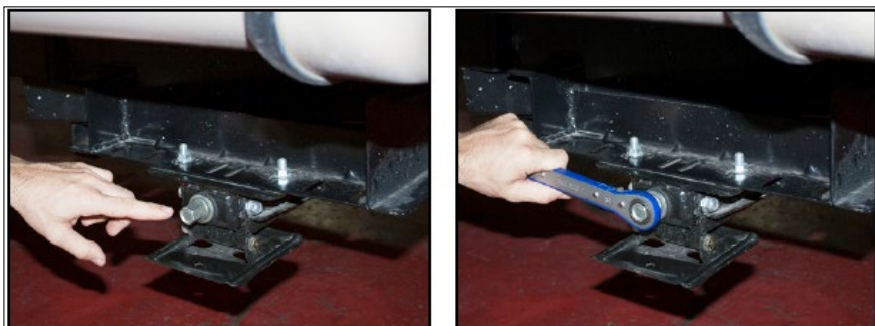

Refer to the manufacturer's owner manual in your warranty packet for further information regarding troubleshooting, error codes, and care & maintenance.

STABILIZER JACKS

⚠ WARNING

DO NOT USE THE STABILIZER JACKS TO LEVEL THE RV. It is important to remember that the stabilizer jacks are to be used only for support while occupying and moving around the RV. They are not designed to support the weight of the RV.

The stabilizer jacks must be fully retracted before moving or towing the RV to prevent stabilizer jack damage.

Each stabilizer jack can be individually adjusted to stabilize the RV for use.

When setting up on soft ground, you may wish to place a wood pad or the equivalent under each stabilizer jack foot to help keep the jack from sinking into the ground.

Manual Stabilizer Jacks (if so equipped)

1. To lower each jack, insert the jack crank onto the applicable stabilizer jack shaft.
2. Turn the crank clockwise to lower each leg until it contacts the ground and stabilizes the RV.

To raise each jack, insert the jack crank onto the applicable stabilizer jack shaft and turn the crank counter-clockwise.

Electric Stabilizer Jacks (if so equipped)

Control switches for the stabilizer jacks are typically located on the (door) side of the unit above the stabilizer jack(s).

To lower each jack, press the control switch until each leg contacts the ground and stabilizes the unit.

To raise the jack, press the control switch until the jack is returned to the retracted position.

EMERGENCY STOPPING

Always carry road flares or reflective warning signs. Pull off the roadway as far as possible for emergency stopping. Turn ON your vehicle hazard warning flashers. If traveling at night, use three red warning indicators such as flares, reflectors or lanterns as required by the Uniform Vehicle Code and Model Traffic Ordinance as follows:

1. Place the first warning indicator on the traffic side of the recreation vehicle, directed at the nearest approaching traffic.
2. Place the second warning indicator 100 feet behind the recreation vehicle in the center of the lane and toward approaching traffic.
3. Place the third warning indicator 100 feet in front of the recreation vehicle in the center of the lane and away from the traffic approaching from behind.



NOTE: Curves and/or hills may affect the safe placement of warning indicators.

⚠ WARNING

For personal safety, always stand off the road and out of the way of traffic.

EMERGENCY TOWING

⚠ WARNING

Never allow anyone to go under the recreation vehicle while it is being lifted and/or being towed.

If your recreational vehicle needs to be towed, please contact an emergency road service provider or a qualified service facility for assistance.

WHEEL LUGS

After your first trip, check the wheel lug torque periodically for safety. Check the wheel lugs after winter storage, after a wheel removal, before starting a trip or following extensive braking. See **Wheel Lug Torque Chart**.

1. Use the correct star pattern sequence to attach the recreation vehicle wheels
2. Start all nuts by hand to prevent cross threading.
3. Tighten the nuts in the sequence shown.
4. Tighten the lug nuts equally in stages as indicated for your recreational vehicle wheels

SECTION 4: VEHICLE OPERATION

Check and re-torque after the first 10, 25 and 50 miles (16, 40 and 80 kilometers). Thereafter, check and maintain the torque according to the listed torque values

Because of the importance of having proper torque on the wheel lug nuts, you should always have the wheels mounted and properly torqued by a qualified technician using the proper tools.

NOTE: The proper method of tightening wheel lug nuts is with a properly calibrated torque wrench and socket, not with an impact wrench or by hand. Do not use a 4-way lug wrench or any other type of wrench that does not measure the actual pressure applied to the lug nut.

WHEEL LUG NUT DIAGRAMS:

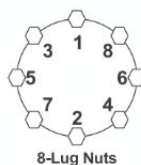
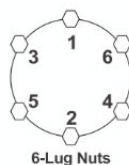
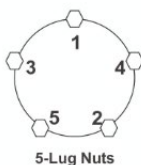
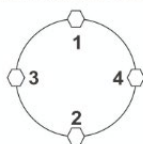

WHEEL TORQUE INSTRUCTIONS:

1. Start lug nuts with fingers on studs to avoid cross threading.
2. Stage 1, Torque: Impact lug nuts in a star pattern* until snug to rim. -- See *Wheel Lug Nut Diagram*
3. Stage 2, Torque: Use calibrated torque wrench to torque each lug nut, in a star pattern, to the values indicated. Wheels must remain stationary during torquing process for control purposes. --See *Wheel Lug Nut Torque Chart* and *Wheel Lug Nut Diagram*
4. Stage 3, Torque: Use calibrated torque wrench to torque each lug nut, in a star pattern, to the values indicated. Wheels must remain stationary during torquing process for control purposes. --See *Wheel Lug Nut Torque Chart* and *Wheel Lug Nut Diagram*

WHEEL LUG NUT TORQUE CHART:

Lug Nut	Stud Dia.	Rim	Type	Stage 1 Impact Gun	Stage 2 Clicker Setting (+/-3ft/lbs)	Stage 3 Clicker Setting (+/-3ft/lbs)	Acceptable Torque Range
4-Lug Nuts	1/2"	12"	Steel	40-50 ft/lbs	60 ft/lbs	70 ft/lbs	50-75 ft/lbs
5-Lug Nuts	1/2"	13"	Chrm/Steel	40-50 ft/lbs	60 ft/lbs	70 ft/lbs	50-75 ft/lbs
5-Lug Nuts	1/2"	14"	Chrm/Steel/Alum	40-50 ft/lbs	95 ft/lbs	115 ft/lbs	90-120 ft/lbs
5-Lug Nuts	1/2"	15"	Chrm/Steel/Alum	40-50 ft/lbs	95 ft/lbs	115 ft/lbs	90-120 ft/lbs
6-Lug Nuts	1/2"	15"	Chrm/Steel/Alum	40-50 ft/lbs	95 ft/lbs	115 ft/lbs	90-120 ft/lbs
6-Lug Nuts	1/2"	16"	Chrm/Steel	40-50 ft/lbs	95 ft/lbs	115 ft/lbs	90-120 ft/lbs
8-Lug Nuts	1/2"	16"	Steel/Aluminum	40-50 ft/lbs	95 ft/lbs	115 ft/lbs	90-120 ft/lbs
8-Lug Nuts	5/8"	17.5"	Aluminum	50-60 ft/lbs	125 ft/lbs	150 ft/lbs	140-160 ft/lbs

TRANSPORTATION INSTRUCTIONS:

1. Prior to travel and after excessive braking, all wheel lug nuts must be checked for torque.
*This also applies to any service involving wheel or lug removal, during the life of the recreational vehicle.
2. Torque readings must fall within the Acceptable Torque Range. --See *Wheel Lug Nut Torque Chart*
3. Torque specifications, must be checked by using a torque wrench.
*Digital or Dial Torque Wrenches are recommended.
4. If Torque falls below the Acceptable Torque Range, additional torque is required.
-- See *Wheel Torque Instructions* and *Wheel Lug Nut Diagram* for the correct pattern and recommended final torque value.
5. During travel, wheel lug nuts must be checked and re-torqued, as required, after the first, 10 miles, 25 miles, 50 miles, then periodically during travel (16 kilometers, 40 kilometers, 80 kilometers, then periodically during travel).
-- See *Wheel Torque Instructions* and *Wheel Lug Nut Diagram* for the correct pattern and recommended final torque value.
6. Failure to follow these instructions may result in wheel loss, an accident, or loss of control, resulting in death or serious injury.

⚠ WARNING

- ❑ Check and tighten wheel lug nuts regularly to make sure they did not loosen during travel. Wheel lug nuts must be applied and maintained at the proper torque levels to prevent loose wheels, broken studs and possible separation of the wheel(s) from your recreation vehicle. The lug nuts on the wheels of your recreation vehicle must be maintained according to listed torque values (see Wheel Lug Torque Chart.) Over-torqued and/or under-torqued wheels may result in component failure.
- ❑ Failure to maintain proper torque of the wheel lug nuts could lead to separation of the tire and wheel while driving, possibly resulting in property damage or personal injury.







TIRES

Read and understand the following before taking your first trip in your RV.

Routine maintenance on your RV is important. **To insure your tires are operating safely, regular inspection of the tires and checking tire pressures is absolutely mandatory.**

Alignment, balance and bearing wear will affect tire wear. Make sure to look for cracking, bulging, uneven tread wear, etc.

Tire Wear Diagnostic Chart

Wear Pattern	Cause	Action
 Center Wear	Over Inflation	Adjust pressure to particular load per tire catalog.
 Edge Wear	Under Inflation	Adjust pressure to particular load per tire catalog.
 Side Wear	Loss of camber or overloading	Make sure load doesn't exceed axle rating. Align at alignment shop.
 Toe Wear	Incorrect toe-in	Align at alignment shop.
 Cupping	Out-of balance	Check bearing adjustment and balance tires.
 Flat Spots	Wheel lockup & tire skidding	Avoid sudden stops when possible and adjust brakes.

⚠ CAUTION

Tire wear should be checked frequently. Once a wear pattern becomes firmly established in a tire it is difficult to stop, even if the underlying cause is corrected.

SECTION 4: VEHICLE OPERATION

Tire Pressure

DANGER

Failure to follow proper inflation guidelines may result in tire failure, which, under certain circumstances can cause loss of vehicle control or accidents that may result in property damage, bodily injury and/or death.

You must follow the manufacturer's inflation guidelines for maximum load capacity; under-inflation is just as dangerous as over-inflation.

Proper inflation should be monitored closely. Failure to do so could result in the overheating of a tire causing a blowout. Inflation pressure should be as recommended by the tire manufacturer or as the federal label for the recreation vehicle indicates.

When you are using your Recreational Vehicle, check inflation pressure weekly. Pressure should be checked when the tires are cold. During travel, tires heat up and pressure increases. **Do not bleed air from hot tires or your tires may then be under-inflated.**



NOTE: Cold tire inflation pressure is defined as a tire that has not been used for three or more hours, or has been driven less than one mile. Tire inflation pressure of a hot tire may show an increase of as much as 6 psi over a cold tire.

WARNING

- It is recommended that the tire pressure be checked at the beginning of each trip to obtain the maximum life of the tire. Follow the instructions listed on the Federal Certification label, to determine the correct tire pressure. Under-inflation may cause tire failures and swaying resulting in loss of control, injury, death or property damage.

TOWABLE PRODUCTS ONLY

- Towable recreation vehicles are equipped with special trailer (ST) tires that have a maximum speed rating of 65 MPH (104 km/h). **You should not exceed this speed rating.** Exceeding the tire speed rating may result in tire failure, which could lead to an accident causing serious injury or death.

CHANGING A TIRE

⚠ WARNING

- Do not use the stabilizer jacks to support the recreational vehicle while under the vehicle or changing tires. The stabilizer jacks are designed as a stabilizing system only. Do not use the stabilizer jacks as a jack or in conjunction with a jack.
- Never raise the recreational vehicle by placing the jack under the axle, springs or any attachment parts.

Failure to comply with these guidelines could result in damage to the vehicle and risk causing serious injury or death.

When replacing tires:

- Be sure to use only tires that are rated for recreation vehicle use. The use of passenger tires should be avoided. The load rating/range embossed on the sidewall of passenger tires must be de-rated accordingly; they do not have the same load capability as tires that are specifically identified for recreational vehicle use. Failure to use tires that are properly matched to your recreational vehicle could lead to premature tire wear or less than optimum trailer handling.
- Be sure to replace it with a tire of the same size and specifications (refer to the Federal Certification label.)

If you experience a flat tire on your recreational vehicle while driving, gradually decrease your speed and move the recreational vehicle to a safe place on the side of the road.

1. Keep the recreational vehicle attached to the tow vehicle. Block the tire on the opposite side of the recreational vehicle from the tire you are changing.
2. Loosen the wheel lug on the tire you are changing before jacking up the vehicle. DO NOT remove the lug nuts; only loosen them for ease of removal when the tire is off the ground.
3. Locate the mainframe rail of the trailer (it spans from front-to-back just inside the tires).
4. To raise the recreational vehicle, place the jack (hydraulic or screw) under the main frame rail. It must be just ahead of the front tire or just behind the rear tire.

Tire Replacement

Any service or warranty coverage on tires is to be handled by the tire manufacturer or the store representing the brand installed on your recreation vehicle. They are not to be returned to your dealer or recreation vehicle manufacturer.

If you have questions regarding your tires, contact the tire manufacturer.

SECTION 4: VEHICLE OPERATION

SPARE TIRE CARRIER (IF SO EQUIPPED)

If your recreational vehicle is equipped with a spare tire, it will either be mounted under the unit (hoist) or on the rear bumper.

Hoist Mount

⚠ WARNING

DO NOT exceed the maximum load capacities of 100 lbs. for the hoist. DO NOT use air driven guns or impact wrenches to lift the spare tire to the travel position.

Depending on your model, the spare tire may have (side or bottom) brackets or it will be mounted against the underside of the recreation vehicle (flush mount) to give it stability in travel.

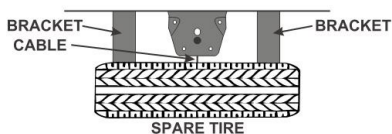

Bracket Mount Travel Position



Hoist Mount Travel Position

NOTE: If your spare tire is a flush mount application, it must make contact with the underside of the recreational vehicle to insure maximum road clearance and stability in travel. Raising and lowering the hoist

Raising and lowering the hoist

The crank handle to raise and lower the tire will be located (fastened to the sidewall) in a basement compartment of the recreational vehicle. Insert the crank handle into the crank access port located either in the center of the rear bumper, or on the sidewall of the RV. Turn the crank handle to raise/lower the tire. Two “crisp breaks” must be heard and felt to insure the proper seating of the tire for travel.

NOTE: If the manual crank access port is located in a slideout, the slideout room must be in the travel position to allow the crank to reach the mechanism used to raise or lower the tire.

SPARE TIRE
MANUAL CRANK

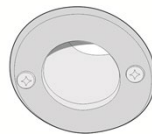

Crank Access Port

Securing the spare tire

To secure the spare tire in the travel position, put the steel hoist lift support located on the end of the cable through the rim of the tire. The hoist lift support clips need to seat inside the center hole of the tire rim. The valve stem of the tire **MUST** be pointed up (toward the bottom of the RV).



Bumper Mount

The spare tire bracket can be released and extended down to access a storage compartment at the rear of the trailer without removing the tire.

To extend the tire down

1. Remove the cotter key from the pin holding the tire carrier in place.
2. Remove the pin and extend the carrier away from the trailer.



Always return the tire carrier to the upright position and lock it in place while traveling.

To remove the tire from the tire carrier

1. Remove the lug nuts holding the tire in place.
2. Remove the support bracket from the bottom lug.
3. Pull the tire from the tire carrier.

To install the tire on the tire carrier

1. Place the tire on the carrier with the top lug bolt inserted into one of the holes in the tire rim and the bottom lug bolt in the center of the rim.
2. Install the top lug nut.
3. Place the support bracket over the bottom lug bolt across the center of the rim.
4. Install the bottom lug nut over the support bracket.
5. Tighten the lug nuts securely before returning to travel.



Bumper Mount

Vinyl Tire Cover (if so equipped)

Your tires are manufactured with components that cause “bleeding” onto the tire cover. To prevent this, it is recommended to use a separator (garbage bag, paper, cloth, etc.) between the tire and the cover.

SECTION 4: VEHICLE OPERATION

SETTING UP YOUR RECREATION VEHICLE

- Position the RV as desired.
- Level the RV (side-to-side). Leveling your recreation vehicle is important as the water drainage systems are designed with proper slope and must be level for proper operation, and the appliances perform best when level.
- Block the wheels securely to prevent the RV from moving.

Travel Trailer Set Up

1. Unhook the wire harness/connector plug, safety chains and breakaway switch lanyard.
2. Install the dolly wheel or platform.
3. Release the weight distributing bars (customer supplied).
4. Open the tongue jack coupler latch.
5. Turn the tongue jack crank to raise the coupler above the hitch ball.
6. Level the RV (front-to-back) with the tongue jack crank.
7. Lower stabilizer jacks (If applicable).
8. Pull the tow vehicle away, as desired.

Fifth Wheel Set Up

9. Drop the landing gear (important!) See the operator's manual for proper operation.
10. Disconnect the wire harness/connector plug and breakaway switch lanyard.
11. Drop the truck tailgate (if applicable).
12. Gently put your truck into reverse (don't give it any fuel/acceleration). This effectively moves the kingpin off the locking bar that will allow you to disengage it.
13. Step on brake and apply parking brake.
14. Disengage the locking bar and unhitch.
15. Drive away.
16. Adjust the fifth-wheel height for proper front to back leveling of the RV.

AWNINGS (IF SO EQUIPPED)

WARNING

Awnings must be closed (and locked if applicable) while the RV in transit.

CAUTION

The effects of wind and rain on an awning are unpredictable and can cause severe damage to the awning and/or the recreation vehicle. **Retract the awning if:**

- If wind or extended periods of rain are expected
- If you leave the RV unattended for a length of time, to avoid unexpected climate conditions.

Awning Care

Keep your awnings clean and in good condition to prevent costly repairs.

- Periodically check that the fasteners are tight. Tighten if necessary.
- Keep the awning fabric clean. For detailed cleaning information, refer to the manufacturer's owner information.

Your recreation vehicle may include one or more of the following options:

- Power window awning
- Slide out awnings
- Power awning over entrance door

Power switches to operate the awnings are typically found in the control panel above the entrance door.

Electric Patio Awning With Remote Control



NOTE: The electric awning requires connection to a 120-volt power source. Make sure you have sufficient power available before operating your awning (refer to Electrical Systems, Calculating electrical load).

In Motion Detector (if so equipped)

Some patio awnings are equipped with a motion detector. If the patio awning experiences extreme or excessive movement, it will automatically retract to the travel mode position.

For detailed safety and operating information, refer to the manufacturer's user guide.

POWER AWNINGS (IF SO EQUIPPED)

⚠ WARNING

Awnings must be closed (and locked if applicable) while the RV is in transit.

⚠ CAUTION

- The effects of wind and rain on an awning are unpredictable and can cause severe damage to the awning and/or the recreation vehicle. If wind or extended periods of rain are expected, retract the awning.
- It is recommended that if leaving the recreation vehicle unattended for a length of time you should retract the awning to avoid unexpected weather conditions.

Each power awning will have its own control switch, which is typically located on the command center switch panel located inside the entrance door. Pressing and holding the switch will extend or retract the awning.

Carefree® Longitude Awnings (if so equipped)

offer the following features:

- Scissor style arms that do not require vertical ground supports.
- Adjustable arms with (6) position pitch adjustment.
- Worm gear driver motor eliminating the need for travel locks.
- Single switch operation, 12V motorized awning.

SECTION 4: VEHICLE OPERATION

Adjusting the Awning Pitch

⚠ WARNING

- ❑ Do not set the individual arm pitch at more than three (3) positions different between the left and right arms. Damage to the arms and the canopy can occur if the awning is retracted when the arms are set at more than three (3) positions difference.
- ❑ **DO NOT USE A 110VAC POWER SOURCE FOR THE EMERGENCY OVERRIDE PROCEDURE!** Doing so will permanently damage the awning! Do not use the Emergency Override without following the directions.
- ❑ **For awnings under 12 feet:** The arms must be set at an equal pitch. Damage to the arms and canopy can occur if the awning is retracted with the arms uneven.

The longitude arms have 6 pitch adjustment settings. The awning can be extended and retracted in any of these positions without resetting the pitch.

NOTE: Use care when adjusting the pitch as the awning may move abruptly.

1. Hold on to the awning arm to keep it steady while adjusting the pitch.
2. Press in the pitch adjustment pins located on the scissor arm. **Applying LIGHT pressure on the arm will decrease the force required to press the pitch adjustment pins.**
3. Slide the scissor arm to the desired set hole – towards the coach for a lower pitch and away from the coach for a higher pitch.

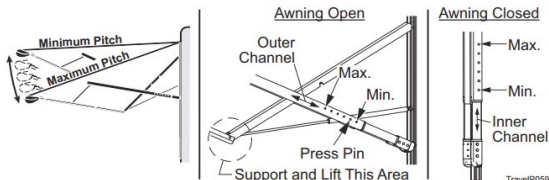

Additional Awning Operation Information

- ❑ Operating the awning repeatedly over a short time period may cause the circuit to sense an overheat condition and shut off the motor. If this occurs, wait approximately 15 minutes to allow the motor to cool then operate the awning in normal fashion.
- ❑ Normal operation time is 28-35 seconds to extend or retract. If the power supply is on the low side of the acceptable voltage range (10VDC– 14VDC) the awning will move slower.
- ❑ Always operate the awning according to the instructions.
- ❑ Periodically check that the fasteners are tight (tighten if necessary).
- ❑ Keep the awning fabric and arms clean.

Refer to the manufacturer's user guide for detailed operating and safety information.

Emergency Operation

If power to the vehicle is not available, the awning can be retracted by jumping the motor using a 10VDC – 14VDC power source such as a cordless drill battery or car battery.

1. Remove the front cover (the cover snaps onto the rear cover). Press on both sides of the rear cover until the front cover releases then lift the cover off.
2. Detach the RED and BLACK wires from the cable to the motor.
3. Attach jumper wires to the motor wires.
4. Connect the other ends of the jumper leads to the 10VDC – 14VDC source. If the awning moves in the wrong direction, reverse the leads. Maintain contact throughout the retraction process.
5. When the awning is closed, remove the jumper wires and reattach the cable wires to the motor wires. Be sure to match RED to RED and BLACK to BLACK.
6. Snap the front cover onto the rear cover. Hang the cover on the top and swing it down until it clicks.

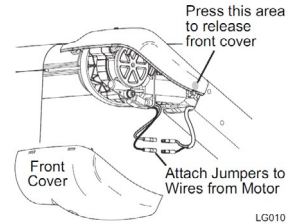

Carefree® Travel'r Awning (if so equipped)

⚠ CAUTION

Power switch should be set to OFF whenever the awning is not being operated and during transport.

- Press the power switch to ON. The Direct Response system is activated and manual controls are active. All functions are disabled if the switch is off.
- Press and hold the EXTEND switch to open the awning.
- Press and release the RETRACT switch. The awning will close completely. To interrupt retraction, press and release the RETRACT switch again.

⚠ WARNING

DO NOT USE A 110VAC POWER SOURCE FOR THE EMERGENCY OVERRIDE PROCEDURE! Doing so will permanently damage the awning!
Do not use the Emergency Override without following the directions.

- When the awning is retracted turn the power switch OFF.

Emergency Operation

If power to the vehicle is not available, the awning can be retracted by jumping the motor using a 10VDC – 14VDC power source such as a cordless drill battery or car battery.

Locate and separate the quick disconnects located in the motor arm channel. Position the wires from the motor on the outside of the channel.

SECTION 4: VEHICLE OPERATION



NOTE: If the awning is equipped with the Direct Response system, this procedure is not applicable. See the manufacturer's owner's manual for additional information.

7. Attach jumper wires to the motor wires. Connect the other ends of the jumper leads to the 10VDC–14VDC source. If the awning moves in the wrong direction, reverse the leads.
8. Maintain contact throughout the retraction process.
9. Hold the wires from the motor on the outside of the channel while closing the awning. This provides access for opening the awning.
10. When power is restored, use the jumper wires and extend the awning to access the cable disconnects. Re-attach the disconnects and secure in the arm channel.

Additional Awning Operation Information

- When rolled out, the fabric may “bounce” creating a wave like motion in the canopy fabric. This can create the appearance of moving jerkily.
- Vinyl may have a tendency to “cling” to the when not used for an extended period of time. Open and close the awning in short bursts 2 or 3 times, the awning will then open normally.

If the awning does not operate, contact the Carefree Service Center. See www.carefreeofcolorado.com for a listing of service centers.

ELECTRIC SLIDE ROOM(S) (IF SO EQUIPPED)

The mechanical components of the slide out are gear driven. Electric powered slideout room systems have a manual override to allow you to extend or retract the slideout room(s) in case of a power loss.

Make sure you have sufficient power available before operating your slideout system. Level the RV prior to extending the slideout.

Slideout switches are typically located inside the RV, either in the command center or on the wall.

⚠ WARNING

- Make sure the interior slideout room path and the slideout room itself is clear of people and objects before operating.
- Keep away from the slide rails and gear assembly when the room is in motion. They may pinch or catch on loose clothing causing personal injury.

Failure to follow these instructions could result in serious injury or death.

⚠ CAUTION

These guidelines should be followed when using your slideout room:

- Make sure the slideout is in the closed position prior to hooking the unit to the tow vehicle.
- The recreation vehicle **must be level** before operating the slideout room. Water leaks and other problems could result if the slideout is operated without leveling the RV.
- Do not place excessive weight** in the slideout room. It can cause the slideout room to malfunction and cause damage to the slideout.
- Do not over extend/retract the slide out room. Release the switch immediately once the room has been fully extended/retracted. Over extending/retracting the slide out room may result in damage to the stop rod and bracket.
- Additional support jacks are not needed under the slideout. Damage can occur to your slideout room from improper use of aftermarket support jacks.

General Slideout Operation:

- The auxiliary battery (customer supplied) must be fully charged** and connected. **If possible, the RV should be hooked up to 120-volt AC power so the converter operates.**
- The RV must be level and the **stabilizer jacks in the extended position.**
- Slideout switches are typically located inside the RV, either in the command center or on the wall.
- To extend the slideout, locate the slideout control switch and press the OUT section of the switch; hold until the slideout room stops (travel time is approx. 25 seconds).
- To retract the slideout, press the in section of the slideout control switch and hold it until the slideout is fully retracted.

SECTION 5: SLIDEOUT SYSTEMS

- Operating the switch after the room is fully extended or retracted may damage the switch and motor.

After the slideout is extended, visually inspect the slideout and the surrounding area to make sure the slideout has extended properly and has adequate clearance from any outside obstructions.

If the slideout is equipped with rubber seals, verify that the corners of the black rubber seal are set up correctly. The seal corners are cut at a 45° angle. The top of the outside seal must overlap the side of the seal to avoid the possibility of water penetration. On the inside seal, the side seal should overlap the top.



Slideout Overlap-Outside



NOTE: For long-term storage it is recommend the room be closed (retracted).

General Slideout Troubleshooting Checklist



NOTE: For additional troubleshooting information, refer to the specific slideout system detail.

If the slideout does not move when the slideout switch is depressed, follow these steps:

- Check the auxiliary battery (customer supplied) for a full charge and good wire connections.
- Check the 12-volt fuse or circuit breaker.
- Check for loose connections at the slideout motor.

If the slideout still will not operate, follow these steps:

- If the slideout is extended, refer to the section on operating the specific slideout system installed on your RV.
- If the slideout is retracted, leave it in that position.

If the slideout extends crooked or only one side moves:

- Follow steps on overriding the specific slideout system installed on your RV.
- You may need to push the side that is not sliding to get it to retract all the way.

Contact your dealer or customer service for repair assistance.

Slideout Systems

Your RV may be equipped with one or more of the following slideout systems.

Flush Floor Slideout

For optimum performance, the slideout system requires full battery current and voltage. Although the system is almost maintenance free, actuate the room once or twice a month to keep the seals and internal moving parts lubricated.

NOTE: For long-term storage it is recommend the room be closed (retracted).

Trouble shooting the flush floor slideout

Refer to the general troubleshooting check list before proceeding.

NOTE: Install transit bars (if so equipped) on the slideout room during storage and transportation.

Electric Operation

Extending/retracting the room

1. Level the unit.
2. Main Power switch at stepwell (locations may vary) must be ON.
3. Verify the battery is fully charged and hooked up to the electrical system.
4. Remove the transit bars (if so equipped) if extending the slideout, and install them if retracting the room for travel.
5. Press and hold the IN/OUT switch in the OUT position until the room is fully extended and stops moving. Hold the switch in the IN position to retract the room.
6. Release the switch, which will lock the room into position. If the slideout switch is held after the room is fully extended or retracted, the control will sense that the room has stopped and will shut the motor off after a few seconds.



Manual Operation for the flush floor slideout

Locate the crank extension under the inside of the frame (**Fig. 1 and 2**). Attach a standard fifth wheel landing gear crank handle, a 3/4" socket and ratchet, or drill and nut driver.

Rotate the extension clockwise to retract the slideout and counterclockwise to extend it.

DO NOT attempt to disengage the motor as the actuator is manual ready.

⚠ CAUTION

- Always disconnect battery from system prior to manually operating system. Failure to disconnect battery can cause electricity to back feed through the motor and cause serious damage to the system as well as void the warranty
- Use **EXTREME CAUTION when extending/retracting the room using the manual override feature**. The gears can be stripped out if the room is manually retracted/extended to its fullest extent and the operator continues to rotate manual override. Damage can also occur to the slide components, slide room structure or trim components. Damages due to misuse of the manual override feature will void any and all claims to the Limited Warranty.

SECTION 5: SLIDEOUT SYSTEMS

MANUAL OPERATION THROUGH FRAME



Fig. 1- Crank Handle

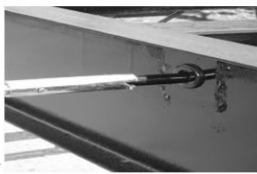

Fig. 2-Through Frame Crank Extension w/Pin

MANUAL OPERATION IN FRAME



Fig. 3-Hex Head Crank Extension



Fig. 4-Ratchet

Schwintek In-Wall Slideout System

The in-wall slideout system requires no maintenance or adjustments. This system has two vertical columns with a drive motor located at the top of each column. The right and left motors are synchronized by a circuit board. Schwintek slideouts are typically used on both towables and motor homes.

NOTE: Do not operate the switch after the room is fully extended or retracted as damage can occur to the motor and/or switch.

To operate the slideout using a wireless remote (if so equipped):

- Press the on/off button to power on the remote.
- Press the corresponding button of the slideout you want to operate.
- Press and hold the (extend/retract) arrow button to move the room in or out.
- Press the on/off button once more to power off the remote.

ALWAYS allow the controller to stop both motors before releasing the switch button.

DO NOT try to time the end of the stroke by releasing the button early.

⚠ WARNING

Do not work on your system unless the 12-volt DC (auxiliary battery) and 120-volt AC electrical systems (shore line power cord) have been disconnected.

Maintenance

This slideout system requires very little maintenance. It contains a pre-lubed bearing that is lubricated when the room is moved in and out. Do not spray oil or grease on the rails while the room is extended.

Trouble shooting the in-wall slideout system

Checking Fuses: The in-wall slide requires a minimum 30-amp fuse. Check the load center for blown fuses and replace any if necessary. If the fuse blows immediately upon replacement, there is a problem with the wiring to the in-wall slide control box. **A qualified service person should be called to check and repair.**

Obstructions: Check both inside and outside for possible obstructions. Also check for smaller objects that may be wedged under the floor or in the sides of the unit. Remove any obstructions before proceeding.

Error Codes: Refer to the error codes section for codes and instructions on how to locate the in-wall slide controller.

Low Voltage: The in-wall slide controller can operate with as little as 8 volts; however with lower voltages the amperage requirement is greater. Check the voltage at the controller and if it is lower than 11 volts, it is recommended that the battery be placed on a charger until it is fully charged. It may be possible to “jump” the RV battery temporarily to extend or retract the room. Consult Customer Service before attempting to “jump” the auxiliary battery.

Only 1 Side Moving: The slide room has a separate motor to operate each side of the room. If only 1 side is moving, with another person’s assistance, press the switch to extend or retract the room while pushing the non-moving side in the appropriate direction. On larger rooms it may be necessary to have 2 or more people pushing the room.

Non-moving side moved manually: Try to push the non-moving side in and out. If a motor shaft has broken it will be possible to move that side of the room several inches by hand. Larger rooms may require several people to push.

Debris in the rack: Check all 4 gear racks on the side of the room for debris.

Status LEDs lights: Locate the slide controller for the slideout in question. Check the status LED lights while pressing the slideout direction switch (in both the extend and retract mode).

Manual override for the in-wall slideout

The slideout system comes with an “electronic” manual override. In event the slide out does not extend or retract follow these steps to override the system which should allow the slideout to be retracted.



NOTE: Fuses for the slideouts can be found in the load center and may be designated as auxiliary or slideout motor.

1. Locate the slideout system controllers. There should be one for each slideout on the recreation vehicle. They are typically located on the forward wall or ceiling of a basement compartment. In some models they may be behind a cargo lined panel.

SECTION 5: SLIDEOUT SYSTEMS

- The malfunctioning controller should have a flashing red LED indicating a halt signal fault (will flash 8 or 9 times).
- Press the “mode button” six times quickly, then press a seventh time and hold for approximately 5 seconds.
- The red and green LED’s will flash indicating you are in override mode. Release the mode button.
- Using either a wall or command center panel switch, press and hold the switch toward the word IN or RETRACT until the unit comes in completely. This will allow you to get the recreation vehicle to a service center to have the slideout malfunction diagnosed.



CAUTION

Call your dealer or Customer Service if:

- During the override procedure the motors are not synchronized. Visually watch the room, and if one side is moving significantly slower than the other (or not at all).
- If the system stalls out before reaching end of stroke OR if the room does not close and seal tightly.

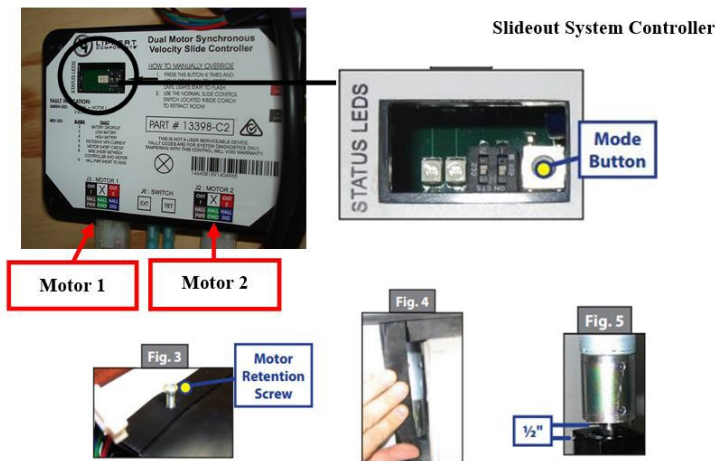

Manually pushing in the slideout

- Locate the slideout system controller.
- Unplug motor 1 and motor 2 connectors at the bottom of the slideout controller. This releases the motor brakes for each motor.
- The slideout room can now be manually pushed in. Larger rooms may require several people to push or pull them.
- Keep both sides of the slideout relatively even while pushing/pulling.
- When the room is completely in, *plug both motor connectors back into the control module. This will apply the motor brakes for road travel.*

Disengage motors, manually retract the room and travel lock

- Locate and remove the motor retention screw which can be found near the top of each vertical column (Fig. 3).

7. Bend back the wipe seal and visually locate the motor (Fig. 4).
8. Pull the motor up until it disengages (about 1/2 inch).
9. Repeat this process for both sides of the slide room.
10. Physically push/ pull the room back into the opening; keep both sides relatively even.
11. The room must be travel locked to keep the room in place for road travel.

WARNING

DO NOT MOVE THE RV UNLESS THE MOTORS ARE PLUGGED IN TO THE CONTROLLER AND THERE IS BATTERY POWER TO THE RV. THIS SETS THE BRAKES ON THE SLIDEOUTS TO PREVENT THEM FROM MOVING DURING TRANSIT.

Error Codes

When an error code occurs during operation, the board LEDs lights will indicate where the problem is. For motor specific faults the green LED will blink (1) time for motor #1 and (2) times for motor #2. The red LED will blink 2 to 9 times depending on the error code. Error codes are as follows:

- 2 times **Battery capacity is low** enough to drop below 6 volts while running.
- 3 times **Battery (low) voltage** is below 8 volts at the start of a cycle.
- 4 times **Battery (high) voltage** is greater than 18 volts.
- 5 times **Excessive motor current** (high amperage) also indicated by (1) side of the slide continually stalling.
- 6 times **Motor short circuit:** motor or wiring to motor has shorted out.
- 8 times **Hall signal not present:** encoder not providing a signal; usually a wiring problem.
- 9 times **Hall power short to ground:** power to encoder has been shorted to ground; usually a wiring problem.

The board will need to be reset after an error code. Energizing the extend / retract switch will reset the board; energizing it a second time will return it to normal operation.

Refer to the Schwintek Slide Room Operation Guide for additional troubleshooting information, or contact Lippert at (866) 524-7821 or at www.lci1.com.

Norco Slideout System

The Norco slideout system is a cable driven slide out used typically on towable products.

- The cables guide the room in or out, while the Accu-Slide mechanism evenly powers the corners keeping the room square.
- Motors and cables are behind the interior fascia board around the slideout opening.
- Cables may stretch over time. Average stretch will be approximately 1/8" but it will not affect the function and does not require adjustment.
- Slideout runs off of the DC power in the RV.
- Rubber wipes prevent debris from entering the unit and actuation guides the bulb seals to close tightly.
- Self-locking motor freezes the room in any position of travel.
- Slideout is supported by rollers or wear bars not the cables. Cables are used to keep the slideout balanced on the rollers.

SECTION 5: SLIDEOUT SYSTEMS

If the room will not activate, generally there is no 12V power to the drive motor. The motor is equipped with a hex drive override shaft.

This drive can be activated using an electric drill and the flexible shaft provided with each unit (or use a ratchet to actuate the motor) to pull the room in or out. **If the motor is functioning, check the room for obstructions.**

Norco Slideout Manual Operation

1. Locate the included flexible shaft in your owner's packet.



2. Attach flexible shaft to the 1/4" hex fitting on the end of the motor.



3. Attach 1/4" socket & ratchet, or drill to the other end, and turn in the proper direction to move the room.
4. If the cables tighten, and the motor is difficult to turn, **REVERSE THE DIRECTION. OVER-TORQUEING CAN HAPPEN, RESULTING IN SEVERE DAMAGE.**



Power Gear Slideout System

Manual Override - The slideout system is equipped with a manual override that allows you to extend or retract the room in the event of a loss of power.

CAUTION

- Always disconnect battery from system prior to manually operating system. Failure to disconnect battery can cause electricity to back feed through the motor and cause serious damage to the system as well as void the warranty
- Use EXTREME CAUTION when extending/retracting the room using the manual override feature. The gears can be stripped out if the room is manually retracted/extended to its fullest extent and the operator continues to rotate manual override. Damage can also occur to the slide components, slide room structure or trim components. Damages due to misuse of the manual override feature will void any and all claims to the Limited Warranty.

If the room does not move when the switch is pressed, check the following:

- Make sure the slideout system is turned on.
- Battery is fully charged and connected.
- Transit bars have been removed (if so equipped).

WARNING

When the motor brake is disengaged the slideout room WILL NOT lock into place and will not be sealed. When the room has been manually retracted, be sure to install transit bars (if so equipped) and return the motor brake lever to its normal engaged position in order to seal and lock the room into position.

If the room still does not move when the switch is pressed, follow the steps below to manually override the slideout room:

1. Turn the Main Power OFF. The override will not work if it has power going to it. **Do not work on the system unless the battery is disconnected.**
2. Locate the slideout controller. There are two versions of the controller.
Version 1, unplug the 6 pin wiring harness from the controller.
Version 2, remove one of the motor leads, either the motor I or motor II lead from the controller.
3. Locate the slideout motor (Fig. 1) mounted to one of the slideout rails. Some models may require removal of the underbelly or cover to access the motor. In a bedroom slideout, it may be located under the bed.
4. Rotate the brake lever, on the backside of the motor, counter-clockwise (looking from the rear of the motor) about 1/8 of a turn to the released position (Fig. 2). This will release the brake that holds the room in place.
5. Locate the manual override for the slideout system (Fig. 1).

SECTION 5: SLIDEOUT SYSTEMS

Fig. 1 - Motor & manual override general location

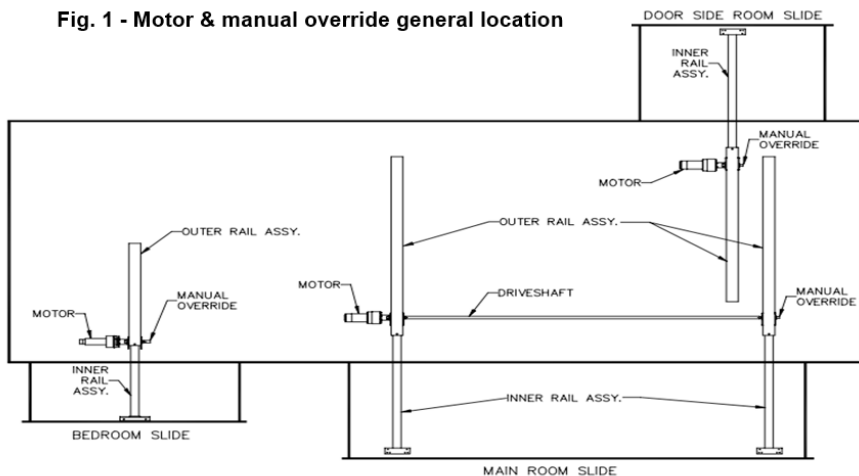

6. The room is now free to move. Using either a 5/8" or 3/4" wrench or socket, crank the room either in or out completely. If the slideout system is supplied with a gearbox override (optional), use the crank handle to move the room.
7. When the room is fully in or out have one person apply pressure to the wrench/ratchet and return the brake lever to its engaged position. This ensures the room is locked into a sealed position.
8. Install the transit bars (if so equipped) to the slideout room and take the unit to an authorized dealer for service.

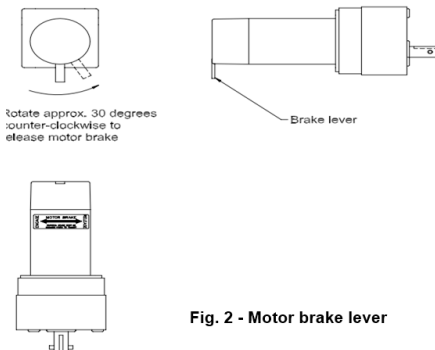

Fig. 2 - Motor brake lever

Refer to the Power Gear® Electric Slideout Operation Manual for detailed operation, safety and troubleshooting information.

Power Gear Slim Rack Slideout System

The Power Gear® Slim Rack slideout is typically used for slideouts 144" long and longer.

- It is operated by a 12VDC electric motor.
- The system is equipped with a manual override allowing the room to be extended / retracted in the event of a power loss.
- The system has a controller (Fig 1) with programmable stops that stop the motor when the room is fully extended or retracted.
- The controller has the ability to detect faults for easier troubleshooting.
- A wall mounted touchpad allows room movement and provides end user feedback.



Fig.1 Slideout Controller

Operating the Slideout

The slideout will not function until the stops are properly set or faults are cleared.

A solid “ON” GREEN LED indicates room movement.

The RED LED indicates a fault or a problem with the system. (Refer to the *Fault Diagnostics / Troubleshooting*).

Prior to moving the slideout room set the parking brake.

To ensure ample voltage is being supplied to the slideout system motor, power should be supplied from one of the following sources:

- Attach the RV to shore power.
- Have the motor home engine running.
- Turn on the generator.

Extending/retracting the room:

1. Engine or generator must be running, or plugged into shore power.
2. Transmission must be in park or neutral (if applicable).
3. Set the parking brake and level the unit.
4. Remove transit bars (if so equipped) if extending the room; install if retracting.
5. Turn **ON** the on/off switch or key.
6. Press and hold the OUT button (Fig 4). To retract, press and hold the IN button. There will be a slight delay before the room begins moving.
7. The GREEN LED should be solid ON when room is in motion.
8. Release the OUT button when the room is fully extended or the IN button when fully retracted, and stops moving.
9. Turn **OFF** the on/off switch or key.

Fault Diagnostics / Troubleshooting:

The control has the ability to detect and display several faults. When a fault is detected, room movement stops and two different LEDs will flash in a pattern.

The RED FAULT CODE LED (Fig 4) will flash a number of times corresponding to a specific fault code (refer to the Fault Code Chart).

The GREEN ROOM MOVEMENT LED (Fig 4) will flash GREEN a number of times corresponding to which motor has the associated fault.

Example: (4) RED flashes and (2) GREEN flashes indicate a motor fault on motor 2.

MAJOR and MINOR faults; faults must be cleared for the room to operate normally.

- **MINOR** faults can be cleared by pushing and releasing the **IN** or **OUT** buttons on the wall touchpad (Fig 4).
- **MAJOR** faults must be cleared by pushing and releasing the **SET STOPS/CLEAR FAULTS** button located on the back of the wall touchpad (Fig 2).

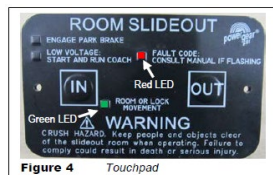
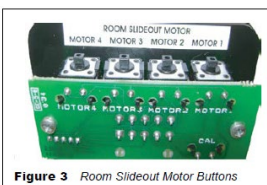
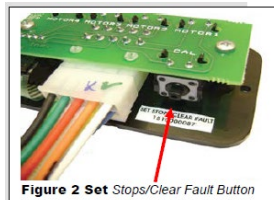
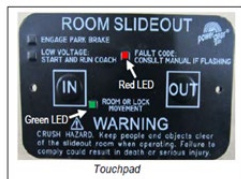

SECTION 5: SLIDEOUT SYSTEMS



NOTE: For MAJOR faults, the control must be overridden by following the EMERGENCY RETRACT MODE in the OVERRIDE MODES section.

Fault Code	Fault Type	Fault Codes		
		Description	Possible Cause	Possible Solution
1	Major	Stops not programmed	-Stops have not been set -Stops were cleared -Stops were improperly set	Steps need to be programmed by an authorized service facility.
2	Minor	System Fault	-Obstruction present -Excessive system drag	Run room in opposite direction. If it continues to move in the opposite direction, remove obstruction, excessive weight in room or repair of damaged component. If room stops moving in opposite direction, observe fault code and refer to this chart
4	Major	Excessive Voltage Battery	-Bad or loose connection -Defective harness -Open or shorted motor	-Check all connections at control box and motor -Check the harness for broken wires. -Put 12.0 VDC direct to the motor. If it does not run replace the motor.
6	Minor		Supply voltage to control box is 17.0 V DC or greater	Check 2-pin power connector at control box. If the voltage is 17. VDC or higher, contact O.E.M for power and ground supplies
		Park brake LED flashing	-Parking brake not set (if applicable) -Ground signal lost at park brake control	-Set parking brake (if applicable) -Check for continuity to ground on wire plugged into park brake connector at control box
		Low voltage LED flashing	Incoming violated to control box is below 12.0 VDC	Check 2-pin power connector at control box. If voltage is below 12.0 VDC contact O.E.M for power and ground supplies.

Preventative Maintenance:

The Power Gear® slideout system requires very little maintenance. Read and follow these procedures:

- When the room is extended, visually inspect the slide rail assemblies. Check for excess buildup of dirt or foreign material; remove any debris that may be present.
- If the system squeaks or makes any noises, blow out any debris from the gear rack arms and apply a dry lubricant to prevent and/or stop squeaking.

Refer to the Power Gear® website (www.powergearus.com) for additional information.

Override Modes:

In the event of component failure or loss of system power, your slideout can be manually overridden and retracted for travel.

NOTE: During the override procedure, the unit will exit this mode if the room has not been moved for two (2) minutes or if a fault is detected during room movement. The Fault Code (RED) and Room or Lock Movement (GREEN) LEDs will flash rapidly for 10 seconds to indicate the override procedure failed. After 10 seconds of flashing, the control will automatically default to FAULT CODE 1. Programming must be restarted.

NOTE: After overriding the system, the room control will need to be re-programmed by an OEM authorized dealer.

Emergency Retract Mode:

Use this procedure when there is **NO** loss of power or electrical problem with the system.

1. Remove the touchpad (Fig 4) from the wall.
2. Prior to clearing the MAJOR fault, record the number of RED & GREEN flashes observed on the touchpad (Fig 6). This information will help your dealer/service center in troubleshooting the slideout system.
3. Press and hold the SET STOPS/CLEAR FAULTS button on the back of the touchpad for five (5) seconds (Fig 2). Both RED & GREEN LEDs will be on solid while pressing this button. After 5 seconds, the GREEN LED will begin flashing and the RED LED will remain solid on.
4. The unit is now ready to retract the room. Press and hold the ROOM SLIDEOUT MOTOR buttons 1 and 2 on the back of the touchpad (Fig 3).

# of RED flashes	# of GREEN flashes

Figure 6

Press the IN button on the front of the wall touchpad until the room is fully retracted. If one

CAUTION

It is very important to note that during this procedure, the slideout control has NO stop locations. Use a second person to assist in determining when the room is retracted. Damage to the room can occur if the room is retracted too far.

side of the room needs to retract further in order to get a good seal, press and hold the motor button (Fig 3) corresponding to ONLY the motor you want to move. Press the IN button on the front of the touchpad to retract the room the remainder of the way.

5. Re-install the wall touchpad.
6. Take the unit to an OEM certified dealer for repairs.

SECTION 5: SLIDEOUT SYSTEMS

Manually Retract Room with Ratchet & Socket:

If the power is lost to the slideout motor(s) or the override mode above will not work, the room may be manually retracted using a ratchet and socket attached to the end of the coupler (Fig 11).

1. Gain access to the VERTICAL CHANNEL assembly from inside or outside of the coach (whichever is more convenient). Remove the trim and flange pieces on the slideout room box.
2. If applicable, remove the top screw from the bulb seal at the top of the VERTICAL CHANNEL (Fig 8).
3. Pull down the bulb seal and remove the motor cover (Fig 9). The motor seal may stick to the bulb seal.
4. Using a pick tool, remove the end of the retaining spring from the motor spring clip (Fig 10A). If not equipped with a retaining spring, loosen the motor retaining screw (Fig 10B).
5. Unplug the motor from the harness and remove the motor by lifting it up and out.
6. Repeat steps 1-4 for the other side.
7. Place a socket wrench with a 3-inch extension and a 5/8" deep well socket (Fig 12) through the motor access opening and seat the socket onto the coupler (Fig 13). One person alternating from side to side of the room can retract a 1500 lb. room with or



NOTE: One person on each side of the room with a ratchet and socket will expedite the process. Room moves ¼ inch for every 30 to 40 degree turn of the wrench.

- without a ramp.
8. Secure the room in place by either:
 - Re-installing the motors (making sure the end of the retaining screw is re-hooked to the motor spring clip (Fig 10A).
 - Torque the motor retaining screw to 40 inch/lbs. (Fig 10B) and the motor retainer is fully engaged.
 - Use a travel lock, (a 2x4 cut to size), etc.
 - Refer to Fig 10A and 10B for proper seating of the motor.**
 9. Have the slideout room serviced by an OEM authorized dealer as soon as possible. Do not operate the room until service is complete as damage to the room may result.

Power Gear Ram Slideout System

Typically used for Class C motorhomes.

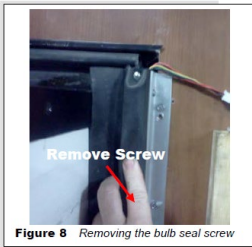

Figure 8 Removing the bulb seal screw

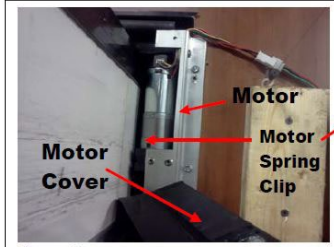

Figure 9



Figure 10A



Figure 10B

NOTE: Motor shown properly seated. No gap between mounting bracket and block.

Motor Retaining Screw

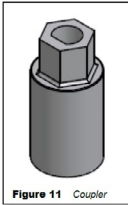

Figure 11 Coupler

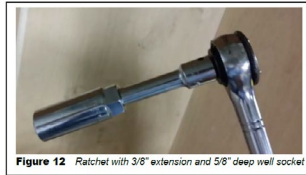

Figure 12 Ratchet with 3/8" extension and 5/8" deep well socket



Figure 13 Ratchet inside motor access with socket on coupler

Manual Override Procedure:

The system has been equipped with 3/4" hex override couplers located on the drive component of the system. Due to the size and weight of some rooms, assistance may be needed to push the room in.

Use the following steps to mechanically operate the room:

1. Locate the ABS motor access cover for the slideout. This cover will be located inside one of the storage compartments under the slide room up at the top of the compartment.
2. Remove 4 screws holding the panel to the top of the compartment. Remove the cover.
3. Unplug the motor leads at the connector. Gray connector with red & black wires.
4. To release the motor brake you must depress the spring lock lever, which then allows you to pivot the brake lever, which in turn releases the brake. These parts are located inside the rubber boot wire tied over the motor. You must manipulate these parts **without** removing the rubber boot. **As noted on the side-by-side photo, removing this boot will void your motor warranty.** These photos will help you figure out how this works. The side-by-side photo (below) shows the spring lock lever and the brake lever.

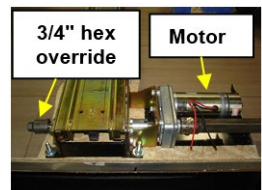
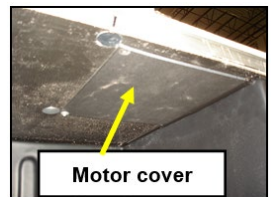

SECTION 5: SLIDEOUT SYSTEMS

5. The spring lock lever is a thin metal arm with a slight bend at the end, which will hold the brake lever in the released position.
6. The brake lever is the heavier thicker metal arm with the hole in the end.
7. The normal position for these two levers is to be parallel to each other as shown in the first side-by-side photo. The motor brake is engaged with levers side by side.
8. The brake lever is moveable; the spring lock lever is not moveable. To release the brake lever, you must push the bent end of the spring lock lever away from the brake lever; this will allow you to pivot the brake lever so it moves over on top of the spring lock lever. The bent end will hold the brake lever in the released position. (photo shows this “bend”)
9. Once the brake motor is released, you will need to remove the skirting on the side of the slideout floor where the hex override is located.
10. Use a ratchet with a 3/4” socket (or wrench) to turn the hex override and manually move the slideout.
11. When the slideout is retracted, check to make sure you have a good seal, and replace the skirting on the slideout.
12. Return the brake release lever back to the “engaged” position (parallel to the spring lock lever). Pressing the bent end of the spring lock lever will allow the brake lever to be moved.
13. Plug the motor connector back in again.
14. Replace the plastic motor cover with the 4 screws removed previously.
15. Take the unit to an authorized dealer for service.

For further information, refer to the manufacturer’s **owner’s manual**.

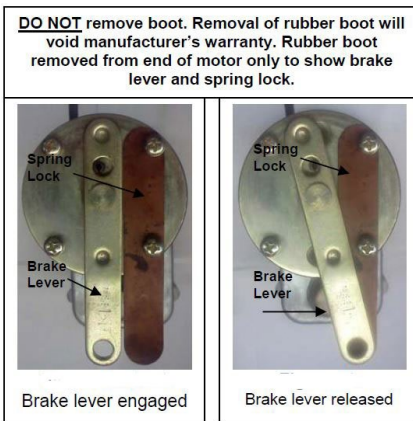

THE ELECTRICAL SYSTEM

The RV electrical system is comprised of two independent electrical systems. One operates off of 12-volt DC power and the other off of 120-volt 60hz AC power. All installations have been made in compliance with industry standards applicable on the date of manufacture. Because the electrical equipment and associated circuitry are engineered into a dedicated system specific to your RV, do not make unauthorized changes or add fixed appliances to it. **Changes or additions made after delivery may result in a hazardous condition.**

Service and/or modification of the electrical system should only be performed by qualified electrical technicians using approved materials, components, and methods meeting current safety and code requirements. Consult your dealer's service department for assistance.

To read more about the various components incorporated into the RV electrical system, please refer to the information contained in your Warranty Packet.

For motorized vehicles, consult the Chassis Guide for information pertaining to the chassis drivetrain electrical system.

Electrical System Maintenance

Before working on the electrical system:

- Make sure the inverter/charger (if so equipped) is turned "off" before disconnecting batteries. Disconnect the shore power cord.
- If equipped with a generator, turn off the generator and disable the automatic generator start functionality (if so equipped).
- Turn off the battery disconnect switch (if so equipped)
- Turn off the 120V main circuit breaker.
- Disconnect the negative 12VDC battery terminal from the battery.

⚠ WARNING

Use caution when using metal tools. If a tool contacts a battery terminal or metal connected to it, a short circuit could occur which could cause personal injury, explosion or fire.

COMMAND CENTER

The command center is typically located inside the entrance door or in the living area of the RV, and contains switches and controls for various electrical functions. Command center applications, configurations and components will vary by model.

Command Center Panel or Command Center Panel with Switch Modules

Items found on these panels may include:

- Fuel gauge and hour meter with switches for fuel pump and fuel levels; fuel station (if so equipped) on/off switch
- Lighted red pump and water heater switches (electric & LP gas)
- Generator start / stop switch; may include hour meter
- Tank heater switches Light switches for porch lights, exterior security lights, interior lights, awning LED lights, front cap LED accent lights, power entry step

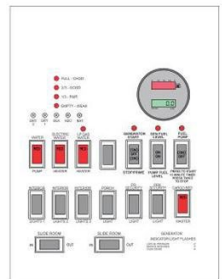

Command Center Panel

SECTION 6: ELECTRICAL SYSTEM

- Cargo bed red lighted control switch
- Slideout control switches (press and hold to extend / retract)
- Awning control switches (press and hold to extend / retract)
- Systems monitor with LED indicators for tank levels and battery charge status
- Auto leveling control panel (for leveling the RV)
- Inverter panel (power switch with display)
- Power bunk bed lift control switch
- Speaker selector switch

Command Center Modules Mounted to the Wall

Some models may have the modules mounted directly to the interior wall of the vehicle. They are typically located near the entrance door. Touch Dimmer Switch:

Certain models may include a touch dimmer switch next to the Command Center panel. (There are no interior light switches on the Command Center panel).

- Turn ON ceiling lights: Tap the LED light on the dimmer
- Turn OFF ceiling lights: Tap the LED light on the dimmer
- Dimmer: If lights are off, hold finger on the LED light and lights will begin turning on gradually until fully lit. If lights are on, hold finger on the LED light and lights begin to gradually turn off.

The dimmer has a memory so it remembers what the light setting was when the lights were turned OFF. When turned ON again, the lights return to that same setting.



Command Center Panel
W/Switch Modules



NOTE: If your RV model includes the 5 way/8 way remote control: the LIGHT button on the remote only controls the awning LED lights.

GFCI RECEPTACLE

There is a ground fault current interrupter (GFCI) engineered into the electrical system. It is designed to reduce the possible injury caused by electric shock. The GFCI will not protect against short circuits or circuit overloads.

Test all GFCI receptacles monthly

- Push in the GFCI “TEST” button. The GFCI “RESET” button should pop out indicating the GFCI receptacle has been “tripped” and interrupted 120-volt power.
- Push in the GFCI “RESET” button to restore 120-volt power.

Contact your independent dealer for assistance if the GFCI “RESET” button does not restore 120-volt power and pops back out.

A “tripped” GFCI breaker indicates that abnormally high 120-volt current flow (a ground fault) was detected. All ground faults must be repaired before use of the recreation vehicle. If the GFCI “RESET” button does not restore 120-volt power and pops back out. Contact your dealer for assistance.

5-WAY & 8-WAY POWER REMOTE (IF SO EQUIPPED)

This system gives you remote control over several functions in your RV. The 5-way remote will operate (4) systems (with motors) and (1) light circuit. The 8-way remote will operate (7) systems (with motors) and (1) light circuit. Examples of systems with motors include stabilizers, slideouts, and awnings. Both remotes operate in a similar fashion; the 8-way will have more “pages” on the display since it will operate more devices. The handheld remote is located in a holder inside the entrance door.



Remote Operation:

To power on the remote, press the silver (HOME) button. The display will prompt you for a pin and show numbers on the screen. The default pin is 0,0,0,0. You should create a personal pin number. After you enter your pin number, the remote will display a menu of devices that can be controlled. To power off the remote, press and hold the “HOME” button for 5 seconds until the display goes dark.

Programming a Pin:

The PIN code for the handheld remote provides personalized security, as well as a safety feature to prevent inadvertent activation of functions. These instructions apply only to the LCI wireless remote.



Reset the handheld remote PIN code:

1. Press the silver “HOME” button to turn the remote ON.
2. Press and release the “HOME” button five times. The button with a picture of a key changes to the word “CONFIG”.
3. Press the “CONFIG” button. (Fig 1-A).
4. The remote will ask to reset the screen lock PIN code (Fig 2).
5. Press “Yes” (Fig 2-A).
6. The remote will display a message that the PIN has been reset (Fig 3).
7. Press “HOME” button and press “Set PIN” (Fig 4-A).
8. Enter a 4-digit PIN code (Fig 5).
9. Press “SAVE” (Fig 6-A).
10. Press “HOME” button.

When the keypad appears on the screen, enter the new 4-digit PIN (Fig 7).



SECTION 6: ELECTRICAL SYSTEM

Operating the handheld remote

1. The menu screen will show sets of (4) functions (**Fig 8**). Select a function or press “NEXT” for more options (**Fig 8-A**).
2. To return to the previous menu screen press “PREV” (**Fig 9-A**).
3. The awning light can be turned ON and OFF by pressing “LIGHT” in the menu (**Fig 10-A**).
4. Press a component button in the menu (**Fig 10**) to enter the function operation screen (**Fig 11**). To return to the previous screen press the “HOME” button.



Important remote control operating information

- Never attempt to operate a slide-out, awning, stabilizer jack, landing gear, etc from the handheld remote and a corresponding switch (at the command center) at the same time. Doing so can blow one or more fuses on the multi-function receiver.
- Immediately after operation of motor-reversing components using the handheld remote, there is an 8 to 10 second delay where all redundant switches for motor-reversing components are non-functional.
- The “Light” button on the handheld remote will only control the awning light. This circuit does **not** have “soft start” functionality; if turned “ON” with the remote, it must be turned “OFF” with the remote. Likewise, if turned on at the command center panel, it must be turned OFF with the same switch. The handheld remote will enter “Sleep Mode” after 60 seconds of inactivity. Press the “HOME” button to wake it up.

Awning Operation: Select the AWNING 1 switch; the screen opens showing the awning function screen. If there are multiple awnings, there will be a selection for each awning at the left of the screen. Select the awning you want to control, then press and hold the right arrow (extend) or left arrow (retract) buttons. Select the HOME icon to return to the previous screen.

Slide-out Operation: Slide-out switches may be labeled with the slide name, or a number. A list of the slide-outs on your RV will appear on the left side of the screen. Select the appropriate slide-out switch, which opens the slide-out function screen. Press (and hold) the right arrow button to extend the slide, or the left arrow button to retract it. Repeat this action on the remaining slide-outs. Select the HOME icon to return to the previous screen.



Stabilizer Jack Operation: If you have electric stabilizers but **not** an automatic leveling system on your RV, the remote may have stabilizer selections. There may be (2) stabilizer switches; one for front and one for rear jacks (if so equipped). Selecting a stabilizer switch opens the stabilizer function screen. Press and hold the left arrow (Retract) or the right arrow (Extend) to operate the jacks. Select the HOME icon to return to the previous screen.

Calibrating the handheld remote

This procedure affects the location on the screen where the device perceives the screen was touched and where it actually “clicks”. Using a stylus will provide the device with a more accurate point and may ease operation. If it is not accurately responding, use the following procedure:

1. Press the “HOME” button (10) times (**Fig 12-A**).
2. Press the (3) crosshair targets as accurately as possible (**Fig 12-B**).
3. Press (3) more confirmation cross hair targets as accurately as possible (**Fig 13-A**).
4. If all crosshairs are tapped accurately the screen will display “Good Stability” (**Fig 14**). Press the “HOME” button to return to the main screen.
5. If the crosshairs are not tapped accurately the screen will display a message stating “Bad Calibration Tap to Restart” (**Fig 15**). If this happens press anywhere on the screen to restart the procedure.



Batteries

The remote is equipped with rechargeable batteries along with a charger. There are no user replaceable batteries.

TESTING THE CAMPSITE POWER CONNECTION

The campsite 120-volt power receptacle(s) should always be tested for proper functionality prior to plugging the recreation vehicle shore power cord into it.

Campsite 120-volt power receptacles can be tested using a digital multimeter or a dedicated circuit analyzer. Dedicated circuit analyzers plug directly into the campsite power receptacle and minimally test for open neutral, open ground, and correct polarity. **Polarity indicators can be purchased in most electrical and hardware stores.**

⚠ WARNING

Do not hook up the power cord to any receptacle until you have verified proper polarity and grounding.

DO NOT plug the shore power cord into a campsite receptacle(s):

- That has reverse polarity
- With non-functioning ground circuits
- That shows outward signs of heat damage.
- Doing so may result in property damage or serious injury. Plugging the shoreline power cord into an incorrectly wired power source could damage the recreation vehicle electrical system and result in severe or fatal injury. Damage or injury resulting from connection to malfunctioning or improperly wired power sources is not covered by your recreation vehicle warranty.

DO NOT

- Do not use any cheater plug, adapter or extension cord to reconfigure incoming AC power or break the continuity of the circuit connected to the grounding pin.
- Do not connect the power cord into an outlet that is not grounded, or adapt the power cord plug to connect it to a receptacle for which it is not designed.
- Do not remove the grounding pin to connect to a non-grounded receptacle. Removal of the ground pin disables an important safety feature designed to prevent shock and electrocution hazards.
- Do not connect the power cord to an extension cord. Use of an improper extension cord will cause overheating of the cord as well as potentially causing premature failure of the AC equipment.
- The power cord must be fully extended when in use and not left coiled in the electrical compartment or on the ground. If the power cord is left coiled, it may potentially create enough heat to melt its protective casing.

It is the responsibility of the owner of the electrical receptacle to ensure that the receptacle is properly wired and grounded. **Reverse polarity and/or improper grounding of your RV can cause property damage or serious personal injury.**

Connecting The Power Cord

Always test the external power source (i.e., the campsite power receptacle or electrical box) with a ground monitor before connecting your power cord to it. If the ground monitor indicates 'reverse polarity' or an 'open ground' DO NOT connect the power cord.

To help prevent power surges from damaging the connected loads, please follow these instructions when hooking up to the external power source:

1. Turn "off" the load center main 120-volt circuit breaker.
2. Carefully extend the entire length of the power cord (approximately 25'-35') from the electric cable hatch to the external power source.
3. Plug the power cord into the receptacle. Be sure all the power cord prongs are properly plugged into the receptacle.
4. Return to your RV and turn "on" the load center main circuit breaker.

The shore line power cord should be unplugged when the recreation vehicle is left unattended. If something would happen to the electrical system, this may help limit potential damage.

When you are ready to leave, reverse the power cord connection process. Use care to prevent damaging the power cord electrical connection pins when connecting or disconnecting the shore line power cord. Grasp the plug to remove the power cord from the outlet; do not unplug it by pulling on the cord.

Maintenance

Inspect the power cord for cuts, cracks and worn insulation. Have the power cord replaced immediately if these symptoms are noticed.

POWER CONVERTER

The power converter converts 120-volt AC power to useable 12-volt DC power when the shore power cord is connected to an external power source.

The converter has a built-in protective thermal breaker that will shut it down should overheating occur. Overheating can be caused by operating the converter above its maximum power output for an extended period of time, or by an obstruction to its ventilation air flow. To reduce converter heat build keep unnecessary 12-volt lights and motors turned "off". Keep the converters cooling fins and fan clear of obstructions.

- ❑ **USE ONLY A DEEP CYCLE BATTERY FOR RV USE.** Car batteries (CCA rating) are not designed for RV applications. If doing a lot of dry camping use a deep cycle battery rated in amp hours only (NO CCA rating).
- ❑ If using multiple batteries they must be the same brand and type. Adding more batteries will provide longer use of DC appliances when not on shore power but may reduce charging efficiency.
- ❑ The battery works in conjunction with the converter to supply DC power to the RV. A battery is typically only necessary if you do a lot of dry camping or have slideouts and/or a leveling system.
- ❑ Reverse polarity fuse provides protection for the converter when a battery is used. If the battery is connected backwards to the fuse board this fuse would blow preventing damage to the converter.
- ❑ If your lights are dimming or flickering that usually indicates an overloaded converter. Remove some of the load by turning off DC lights or appliances.
- ❑ Fan is controlled by load. It will begin running at 3 to 6 amp DC draw. It increases in speed with a higher load until 14 to 15 amps. Fan is at maximum speed and stays there even with more load. If load drops below 6 amps DC, the fan shuts off.



CAUTION

It is important that the fluid level of any connected batteries be checked on a regular basis. All batteries will “gas” and lose some fluid when continuously connected to any charging source (does not apply to “gel-cell” batteries).

Before checking for converter output voltage, the battery cables must be disconnected at the battery. Make sure the converter is plugged into an AC source (105-132 AC volts). Check the converter output voltage at the battery with a voltmeter. Place the voltmeter probes on the disconnected battery cables. If the voltage reads 13.6VDC with no load, the converter is functioning properly.

If the converter output voltage at the battery reads in the 0.0VDC range, or the battery is not charging, check for:

- An open inline fuse in the battery wire
- An open wire between the converter and the RV battery
- Loose ground connection
- Improper torques

If the converter fuses and AC voltage are good, but the converter output still reads zero volts, the converter is not functioning properly.

Modes of Operation:

Absorption (Normal) Mode: 13.6VDC range. Batteries are being charged, just at a slower rate. Converter will not work without AC input.

Float Trickle Mode: To get your converter into this mode reduce the load on the system to almost nothing but the battery. Let the system sit for approximately 44 hours.

Converter voltage will drop to 13.2VDC. If the converter sees any load during this period or after it is in Float Mode it will revert back to Absorption (Normal) Mode. 13.6VDC.

Bulk Mode: Converter will not jump into the “Bulk Mode” unless the battery is below 50% of charge, or approximately below 13.2VDC output voltage. There is no way to force it to go into Bulk Mode.

Red LED indicates blown fuse.

Inspection and maintenance

If the 12-volt power converter is not working (auxiliary battery not being charged) check the reverse polarity fuse(s) located on the end of the converter.

There are no customer serviceable parts inside the converter case and the manufacturer’s warranty will be void if the case has been removed. If you have further concerns contact your dealer.

For detailed information on operation and safety, refer to the manufacturer’s owner’s manual.

Converter With Charge Wizard (if so equipped)

Some converters may be equipped with a charge wizard. There are (3) possible charging modes; NORMAL, BOOST and STORAGE. The charge wizard will automatically select the best mode to charge your battery. A green LED next to the wizard mode button will indicate by flashes, which mode is currently being used.

NORMAL MODE: Green LED flashes once per second; battery is between 50% and 90% charged. Green LED will flash 2-3 times per second; battery is 90% charged. Output voltage is 13.6VDC and the converter is safely completing the charge of the battery.

BOOST MODE: Green LED is on solid. Output voltage is 14.4VDC to rapidly charge the battery up to 90% of full charge.

STORAGE MODE: Green LED flashes every 6-8 seconds. Output voltage has been reduced to 13.2VDC; the RV battery is fully charged and converter is maintaining the charge.

MANUAL MODE (Not recommended): The wizard mode button is used to override the charge wizard. Refer to the converter owner's manual for additional information.

REVERSE BATTERY PROTECTION: Reverse polarity fuse(s) provide protection for the converter when a battery is used. If the battery is connected backwards to the fuse board a fuse will blow preventing damage to the converter. Four easily accessible fuses are located next to the wizard button. Replace with fuses of the same type and rating.

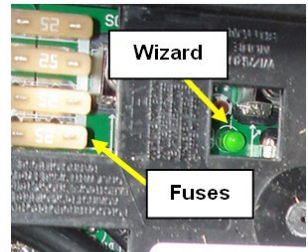

Wizard Button & Reverse Protection Fuses

12-VOLT DC SYSTEM

The majority of your recreation vehicle lighting is powered by 12-volt electricity. The 12-volt DC system is composed of components that will operate when the following conditions are met:

- Power is supplied by the tow vehicle alternator when the engine is running and the 7-way trailer plug is connected. This powers the RV's running lights, brake lights, turn signals and brakes. In addition, the 7-way trailer plug provides a common ground and a 12-volt charge line to charge the auxiliary battery.
- The converter will supply interior 12-volt DC power when the power cord is plugged into campground power. The converter will also charge the RV battery in most situations. (Refer to *Battery Disconnect*)
- The auxiliary battery powers many interior 12-volt components including the lighting fixtures, water pump, 12-volt motors, 12-volt appliances, etc. It also powers the breakaway switch.

12-Volt Fuse Panel

WARNING

Replacement fuses must be of the same voltage, amperage rating and type. **Never use a higher rated replacement fuse;** doing so may cause a fire by overheating the RV wiring.

The 12-volt fuse panel is labeled to indicate fuse sizes, positions and the components powered. **Fuses are located in the load center.**

SECTION 6: ELECTRICAL SYSTEM

Replacing A Fuse

Before replacing a fuse, always turn off the electrical components protected by it.

1. Disconnect the shore power cord.
2. Turn “off” the inverter (if so equipped).
3. Disconnect the house or auxiliary batteries main negative battery cable.
4. Remove the fuse panel cover to check fuses.
5. Pull the fuse straight out of the fuse block.
6. Insert a new fuse of the same specified voltage, amperage rating and type in the original location.

The fuse panel label should be kept permanently affixed to your recreation vehicle. Fuses will not offer complete protection of the electrical system in the event of a power surge or spike.

12-Volt DC Outlet

There may be one or more 12-volt DC power outlets in your recreation vehicle. When the 12-volt DC outlet is used as a power source for an electric appliance, make sure the appliance operates on 12-volt DC power and that it consumes less than 60 watts (5 amps) of power.

WARNING

Keep the protective dust cap on the 12-volt DC outlet when not in use to prevent ingestion of foreign material and potential short circuit conditions.

AUXILIARY BATTERY (CUSTOMER SUPPLIED)

WARNING

- ❑ **Do not store anything inside the battery compartment(s)** or near the batteries that could touch the battery or battery cable terminals. Contact with the battery or battery cable terminals could cause an electrical short circuit, discharge the batteries, or start an electrical fire.
- ❑ **Keep sparks, cigarettes and flames away from the batteries as the hydrogen gas they create may explode.** Do not connect a booster battery or other power source that outputs more than 14.2-volts DC to the RV batteries. Use adequate ventilation when charging or using batteries in an enclosed space. Remove metal jewelry and always wear eye protection when working around batteries.
- ❑ **Do not allow battery electrolyte (acid) to come into contact with skin, eyes, fabric or painted surfaces.** Electrolyte is a sulfuric acid solution that could cause serious personal injury or property damage. If your hands, eyes, clothes or the painted surface of your RV are exposed to electrolyte, flush the exposed area thoroughly with water. If electrolyte gets in your eyes, immediately flush them thoroughly with water and get prompt medical attention.

The combined 12-volt DC loads in your recreation vehicle become more than the converter can produce. This demand can be met by using an auxiliary battery for a limited period of time. The 12-volt system is designed for usage with a Group 27, deep cycle battery.

Dry Camping

The auxiliary battery should be fully charged prior to dry camping. If the auxiliary battery is not being recharged and power is being drawn from it, it will eventually discharge. A battery will discharge at a faster rate as its energy level becomes depleted. Plan your electrical usage accordingly. You can test the auxiliary battery voltage using a volt-ohm meter (customer supplied).

A fully charged auxiliary battery will read 12.7 volts DC and 1.265 specific gravity at 80°F (32°C). The auxiliary battery is considered discharged at 11.89 volts, and dead at 11.65 volts. If the voltage drops below those levels, irreversible damage can occur. Typically, a deep cycle battery has an amp-hour rating of 75-100 amps.

If you run the furnace and refrigerator simultaneously, you will be using approximately (12.0 + 3.0) 15.0 amps per hour. This does not include any 12-volt lights, or any other 12-volt component. If the furnace and refrigerator in this example operated constantly, a 75 amp-hour battery would become fully discharged in 5 hours.

The auxiliary battery should be installed in parallel with the battery in your tow vehicle. When the 7-way trailer plug is connected, both batteries power the RV. Do not allow it to discharge your tow vehicle battery below the level required to start the engine. To prevent this from occurring, disconnect the 7-way trailer plug or install a battery isolator. When the tow vehicle engine is operating with the RV connected, the tow vehicle charging system will charge both batteries.

Replacement and Maintenance

Some equipment in your RV will draw small amounts of current even when turned OFF. To prevent the auxiliary battery from being discharged when your RV is not connected to shore line power, disconnect the auxiliary battery negative cable at the battery. During storage, it is important to check the voltage monthly and recharge the auxiliary battery as needed. If you remove the auxiliary battery from your RV, store it in a dry, cool area per the manufacturer's instructions.

When it is time to replace the auxiliary battery, **replace it with a Group 27 deep cycle battery only**. Do not reverse the positive and negative battery cables (doing so will blow the reverse polarity fuse(s) that protect the converter).

For more information

Please contact the battery manufacturer for additional information on the auxiliary batteries.

Battery Isolator For Your Tow Vehicle (customer supplied)

You may want to consider the installation of a battery isolator on your tow vehicle as a convenience feature:

- It receives current from the tow vehicle alternator and controls distribution of energy to both the RV auxiliary battery and the tow vehicle battery.
- It serves as a check valve to prevent energy from being drawn from your tow vehicle chassis battery (so you can start your tow vehicle engine).

Your dealer can assist you with the selection, purchase and installation.

Battery Disconnect Switch (if so equipped)

The Battery Disconnect switch is typically located in an enclosed exterior compartment. The style of the disconnect switch may vary per model. This switch does not shut off all power, but only shuts off the 12VDC power to the main 12V fuse panel, and the interior of the vehicle. Batteries can still be trickle charged by the converter, and there will still be power to some devices.

SECTION 6: ELECTRICAL SYSTEM

Rotating Dial Disconnect Switch

When this switch is ON, there will be a green area showing a “1” along the top of the switch. To turn the switch OFF, turn it counter-clockwise until you see the red area along the left side of the switch showing a “0” (zero).

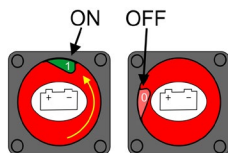

Lever Type Disconnect Switch

To operate this switch, turn the lever counter-clockwise to turn off all 12VDC power to the fuse panel in the RV. The lever can be removed and is equipped with a lanyard to keep the key from getting lost.



Battery Disconnect Switches
Switch appearance may vary by model

LOAD CENTER

The Load Center contains 12VDC fuses and 120VAC circuit breakers for almost all of the electrical appliances and circuits in the RV. The 120V main breaker may be located in this panel and will turn off all 120-volt power to the RV. Locations will vary by model. Refer to the diagram inside the load center for specific fuse assignments.

Not all load centers will include a main breaker.

Motor homes may have separate small panels for breakers and fuses. They are normally located in close proximity to each other typically in the bed platform. The converter is also mounted separately (typically under the bed platform).

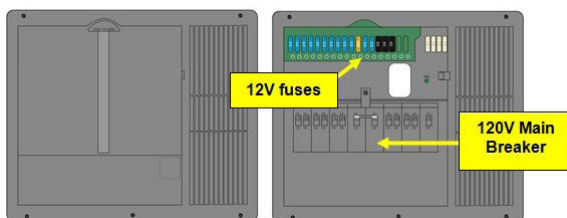

Typical Load Center Panel

Load Center Panel w/120 volt Main breaker
– load center appearance and configuration may vary by model

120-VOLT CIRCUIT BREAKERS

The 120-volt AC circuit breakers located inside the load center protect all 120-volt wiring and components from circuit overloads and short circuits. Should a circuit overload or short circuit occur the circuit breaker protecting the affected circuit will “trip” preventing the flow of electricity through that circuit.

If a circuit breaker trips, shut “off” the appliance on that circuit (i.e., power converter etc.) and allow the circuit breaker to cool down for a brief period of time. After it cools down, reset the circuit breaker by moving its lever “off” and then back to the “on” position. If the circuit breaker re-trips or frequently trips, contact your dealer to have the electrical problem diagnosed and repaired.

A circuit breaker identification label is permanently attached to the inside surface of the 120-volt Load Center.



NOTE: Load Centers may not always include a main circuit breaker.

CAUTION

Circuit breakers and fuses will not offer complete protection of the electrical system in the event of power surge or voltage spike.

Replacement

Only replace circuit breakers with those of the same specified type, voltage, and current rating. **Never replace a circuit breaker with one listed at a higher amperage rating.** Please contact your dealer for repair assistance when replacing circuit breakers.

WARNING

Replacement circuit breakers must be of the same voltage, amperage rating and type. Never use a higher rated replacement circuit breaker; doing so may cause a fire by overheating the RV wiring.

Maintenance

At the beginning of camping season, inspect the circuit breakers and replace as needed. Test by turning each circuit breaker “off” and back “on”. Circuit breakers are wearable parts and must be replaced as needed, as part of your RV maintenance. If you have any questions, consult your dealer.

A label is provided to explain the function of every 120-volt circuit breaker. This label is located on or near the appropriate load center or sub-panel and must remain permanently affixed to the recreation vehicle.

SECTION 6: ELECTRICAL SYSTEM

APPROXIMATE ELECTRICAL LOAD RATINGS

12 Volt System	
Exterior Entertainment Center	5-7 AMPS
Fan	1.5 AMPS
Furnace	12.0 AMPS
Generator Start	95.0 AMPS*
Illuminated Switch	.125 AMP
Inverter	variable
Leveling System	95.0 AMPS*
LP Detector	.125 AMP
Light; Halogen	1.7 AMPS
Light; Vanity	4.2 AMPS
Lights; Aisle	1.0 AMP
Lights; Baggage Compartment / Shower	1.4 AMPS
Lights; Decorative Wall / Map / Porch	1.5 AMPS
Lights; Fluorescent Double -12"	2.0 AMPS
Lights; Fluorescent Double -18"	2.5 AMPS
Power Awning	10.0 AMPS
Power Vent	5.0 AMPS
Refrigerator	3.0 AMPS
Step Cover	10.0 AMPS
TV Plate/Antenna Booster	1.0 AMP
Water Heater	6.0 AMPS
Water Pump	7.0 AMPS

*Momentary Load

12 Volts: Labeled watts divided by 12 = Power consumed in AMPS

120 Volt System	
Air Conditioner	18 AMPS
Coffee Maker	6-12 AMPS
Converter (each)	8 AMPS
DVD System	3 AMPS
Fireplace	12 AMPS
Hair Dryer or Curling Iron	10-14 AMPS
Microwave	12 AMPS
Refrigerator	6 AMPS
Satellite Receiver	2 AMPS
TV	2-4 AMPS
Vacuum Cleaner	8 AMPS
Washer/Dryer	12 AMPS
Water Heater	12 AMPS

120 Volts: Labeled watts divided by 120 = Power consumed in AMPS

120-VOLT (30 AMP) AC SYSTEM (IF SO EQUIPPED)

The 30 amp 120-volt 60hz AC electrical system is designed to operate on 1 leg of 120-volt power at a maximum current flow of 30 amperes.

Exposure to voltages higher or lower than a nominal 120-volts will damage or shorten the service life of the electrical system and appliances. The 30 amp 120-volt 60hz AC electrical system can be powered by the 120-volt 60hz utilities found in RV campgrounds or by 120-volt 60hz generator power.

The following electrical components will only operate when your recreation vehicle is connected to shore or generator power: 120 to 12-volt power converter, air conditioner, refrigerator, microwave oven, television(s), home theater system(s), electric water heater, washer, dryer, fireplace, and appliances plugged into convenience receptacles.

 WARNING

- Make certain the external power source you connect the power cord to is a properly wired **30 amp NEMA TT-30** RV receptacle and not 240-volt AC. **PLUG INTO 30-AMP SERVICE ONLY.**
- Circuit breakers and fuses will not offer complete protection of the electrical system in the event of power surge or voltage spike.

30-AMP Power Cord (if so equipped)

 WARNING

- Do not hook up the power cord to any receptacle until you have verified proper polarity and grounding. Polarity indicators can be purchased in most electrical and hardware stores.
- Do not use any cheater plug, adapter or extension cord to reconfigure incoming AC power or break the continuity of the circuit connected to the grounding pin.
- Do not connect the power cord into an outlet that is not grounded, or adapt the power cord plug to connect it to a receptacle for which it is not designed.
- Do not remove the grounding pin to connect to a non-grounded receptacle. Removal of the ground pin disables an important safety feature designed to prevent shock and electrocution hazards.
- Do not connect the power cord to an extension cord. Use of an improper extension cord will cause overheating of the cord as well as potentially causing premature failure of the AC equipment.

It is the responsibility of the owner of the electrical receptacle to ensure that the receptacle is properly wired and grounded. Reverse polarity and/or improper grounding of your recreation vehicle can cause personal injury or death.

The 30-amp external utility power cord is commonly referred to as the “shore” power cord. It is designed to mate and properly function with 30-amp “shore” power receptacles available at most campgrounds.

SECTION 6: ELECTRICAL SYSTEM

The shore power cord is designed to continuously carry the 30-amp current flow required to power each leg of the electrical system. It also creates a critical ground connection between the vehicle electrical system and the campground shore power receptacle.

Always test the external power source (i.e., the campsite power receptacle or electrical box) with a ground monitor before connecting your power cord to it. If the ground monitor indicates 'reverse polarity' or an 'open ground' **DO NOT** connect the power cord.

Regularly inspect the shore power cord for cuts, cracks, worn insulation and other damage. Have the power cord replaced immediately if problems exist.

Calculating 30 AMP Electrical Load (if so equipped)

When connecting appliances to the electrical system, 120-volt power usage is limited to a total of 30 amps. Operating appliances collectively places an added load on your 120-volt electrical system.

An unintentional "trip" of a circuit breaker may occur if you overload the recreation vehicle and/or campground electrical system. The amperage rating of individual appliances can be calculated by dividing appliance wattage consumed (normally listed on the appliance) by nominal design voltage (120 for a 120-volt appliance). For example: 1200 watts divided by 120-volts equals 10 amps.

120-VOLT (50 AMP) AC SYSTEM (IF SO EQUIPPED)

The 50 amp 120-volt 60hz AC electrical system can be powered by an outside 120/240-volt 60hz utility service like those commonly found in campgrounds or by 120/240-volt 60hz generator power. The entire system is designed to operate on 2 legs of 120-volt power at a maximum current flow of 50 amperes per leg.

Exposure to voltages higher or lower than a nominal 120-volts, will damage or shorten the service life of the electrical system and appliances. The 50 amp 120-volt 60hz AC electrical system can be powered by an outside 120/240-volt 60hz utility service like those commonly found in campgrounds or by 120/240-volt 60hz generator power.

The following electrical components will only operate when connected to 120-volt power: air conditioner(s), refrigerator, microwave oven, television(s), home theater system(s), water heater, washer, dryer, fireplace, electric stove, and appliances plugged into convenience receptacles.

WARNING

- Circuit breakers and fuses will not offer complete protection of the electrical system in the event of power surge or voltage spike.
- Make certain the external power source you connect the power cord to is a properly wired **50 amp NEMA 14-50** RV receptacle and not 240 volt AC. **PLUG INTO 50-AMP SERVICE ONLY.**

50-AMP Power Cord (if so equipped)

WARNING

- Do not hook up the power cord to any receptacle until you have verified proper polarity and grounding. Polarity indicators can be purchased in most electrical and hardware stores.
- Do not use any cheater plug, adapter or extension cord to reconfigure incoming AC power or break the continuity of the circuit connected to the grounding pin.
- Do not connect the power cord into an outlet that is not grounded, or adapt the power cord plug to connect it to a receptacle for which it is not designed.
- Do not remove the grounding pin to connect to a non-grounded receptacle. Removal of the ground pin disables an important safety feature designed to prevent shock and electrocution hazards.
- Do not connect the power cord to an extension cord. Use of an improper extension cord will cause overheating of the cord as well as potentially causing premature failure of the AC equipment.

It is the responsibility of the owner of the electrical receptacle to ensure that the receptacle is properly wired and grounded. Reverse polarity and/or improper grounding of your recreation vehicle can cause personal injury or death.

The 50-amp external utility power cord is commonly referred to as the “shore” power cord. It is designed to mate and properly function with 50-amp “shore” power receptacles available at most campgrounds.

The shore power cord is designed to continuously carry the 50-amp current flow required to power each leg of the electrical system. It also creates a critical ground connection between the vehicle electrical system and the campground shore power receptacle.

Always test the external power source (i.e., the campsite power receptacle or electrical box) with a ground monitor before connecting your power cord to it. If the ground monitor indicates ‘reverse polarity’ or an ‘open ground’ **DO NOT** connect the power cord.

Regularly inspect the shore power cord for cuts, cracks, worn insulation and other damage. Have the power cord replaced immediately if problems exist.

Calculating 50 AMP Electrical Load (if so equipped)

When connecting appliances to the electrical system, remember that 120-volt power usage is limited to 50 amps per electrical system leg for a total of 100 amps. Each operating appliance collectively places an added load on your 120-volt electrical system.

An unintentional “trip” of a circuit breaker may occur if you overload the recreation vehicle and/or campground electrical system. The amperage rating of individual appliances can be calculated by dividing appliance wattage consumed (normally listed on the appliance) by nominal design voltage (120 for a 120-volt appliance). For example: 1200 watts divided by 120-volts equals 10 amps.

SECTION 6: ELECTRICAL SYSTEM

SOLAR PREP (IF SO EQUIPPED)

Your recreation vehicle may be wired with a (exterior) plug in that will allow the batteries to be trickle charged using a free standing solar panel. In most models, the solar panel kit is a customer purchased and installed option. The solar plug location will vary by model, but may be located either on the sidewall, on the A-frame of the vehicle or in the outside utility center.

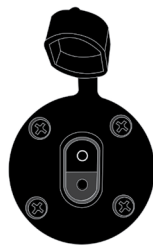

Solar Plug

NOTE: Some models may include a solar panel connection on the roof.

There are capped off wires located in the area of the battery. These wires are the battery charging wires. Once these wires are properly connected to your battery, you will then be able to plug the solar panel into the charging port.

When the system is connected properly, the solar panel will supply power to the battery, the battery will supply power to the converter, and the converter will supply power to all the 12V systems as needed.

REPLACING LIGHT BULBS

Before replacing a bulb, be sure the light is off. Do not touch the glass part of the new bulb with your bare fingers. The skin oil left on the glass will evaporate when the bulb gets hot, the vapor will condense on the reflector and it will dim the surface.

Replacement light bulbs must be of the type, voltage and wattage listed on the lamp fixture. Use of incorrectly sized bulbs can overload lamp circuits and may create a fire hazard by overheating the fixture.

EXHAUST GAS FUMES

⚠ WARNING

- Avoid inhaling exhaust gases as they contain carbon monoxide, which is a potentially toxic gas that is colorless and odorless.
- If you are in a recreation vehicle with either a nearby tow vehicle engine running or the generator (if so equipped) running there is a potential for exhaust fumes to filter back into the recreation vehicle

To avoid breathing exhaust gases, follow these precautions:

- Always shut OFF the tow vehicle engine, generator engine (if applicable), etc., while refueling.
- Do not run the tow vehicle engine, generator engine (if applicable), etc., in confined areas, such as a closed garage, any longer than needed to move your RV in or out of the area.

SECTION 7: FUEL & PROPANE SYSTEM

- Windows should be closed while driving or running the generator (if so equipped) to avoid drawing dangerous exhaust gases into the RV.
- If you suspect that exhaust fumes are entering the RV have the cause determined and corrected as soon as possible.

The best protection against carbon monoxide entry into the RV is a properly maintained ventilation system and an active carbon monoxide detector. To allow for proper operation of the RV ventilation system, keep the ventilation inlet grill(s) clear of snow, leaves or other obstructions at all times.

See the *Occupant Safety* section of this manual for additional information on carbon monoxide safety.

PROPANE GAS SYSTEM

Propane or LP (liquefied petroleum) gas is an efficient form of energy when proper handling and safety precautions are observed. The propane system in your RV furnishes the fuel for cooking, heating, hot water and can be an alternative energy source for refrigeration.

Propane is heavier than air; and tends to flow to lower areas and will sometimes pocket in these low areas, such as the floor. Your recreation vehicle is equipped with a propane alarm (refer to the *Safety Precaution* section, Combination (CO)/Propane Alarm.)

WARNING

Propane cylinders should not be placed or stored inside RV. LP-gas cylinders are equipped with safety devices that relieve pressure by discharging gas into the atmosphere.

The propane fuel system is comprised of numerous components such as the propane container, hoses, the propane gas regulator, piping and copper tubing to each appliance.

Although your recreation vehicle has been carefully tested at the factory, and by your selling dealer for leakage, travel vibrations can loosen fittings. Have the propane system checked at all connections soon after the purchase of your recreation vehicle, and after the initial filling of the propane tanks.

Continued periodic checks of the propane system at 5,000 miles of travel (or at least once a year), by a qualified propane service representative as part of your normal maintenance is recommended. Hand tighten the LP gas system valves only, do not use a wrench or pliers as over tightening may damage the valve seals and cause them to leak.



NOTE: All propane lines have been checked with air pressure at the time of manufacture. Dealers are required to recheck and adjust pressure before retail delivery.

Propane Gas Container

WARNING

- ❑ **DOT propane cylinders must be transported and stored in an upright position so the pressure relief device will function properly.** Laying a DOT propane cylinder on its side may potentially create a very dangerous situation.
- ❑ **The pigtail hose must be installed to avoid tension or pulling stress at either end of the hose.** Keep the pigtail hose away from sharp edges of the cylinder collar, rigid corners, walls, doors or other compartment structures including the cover.
- ❑ **Before entering a propane or fuel service station make sure all pilot lights are extinguished.** Shut off gas to all appliances by closing the propane gas main shut off valve. Always shut OFF any engine before refueling. Do not smoke and do not operate other ignition sources while refueling.
- ❑ **If you suspect your propane container has been overfilled, contact your dealer or a qualified propane technician for assistance immediately.** Do not attempt to service a propane container overfill yourself.

Propane “container” is a general all-inclusive term used to describe a vessel that is used for storage and delivery of propane gas.

The most common of these are:

DOT (Department of Transportation) cylinders are transportable and are commonly used on recreation vehicles. The capacity of DOT propane cylinders is expressed in pounds. DOT propane cylinders are required to be removed from the RV for filling and must be filled by weight by a qualified propane facility. DOT Propane cylinders are equipped with an OPD (over fill protection device) designed to reduce the potential of overfilling. DOT propane cylinders are also equipped with an ACME service valve that is for connection of the TYPE 1 ACME pigtail hose assembly to the RV two-stage regulator.

The TYPE 1 ACME pigtail hose assembly is a wrenchless, right hand threaded connector that features a thermally sensitive sleeve and excess flow device. Max output is 200,000 BTU/hr. It is used to connect propane cylinders to regulators, hoses and other fittings. It is not for use on gas grills and other low pressure devices. DOT cylinders equipped with an OPD and ACME type 1 service valve are identified by the triangular service valve knob.

DOT cylinders are typically marked with “top” or an arrow to indicate the correct orientation of the cylinder(s). Do not mount, store or transport any cylinder other than the in proper position indicated.

Be sure to securely re-install DOT cylinder(s) after they have been removed for filling or replacement. Always close the service valve and install a dust cap or plug when transporting or storing disconnected containers whether full or empty.

ASME tanks are permanently mounted to the RV and are commonly used on RV motor homes. The capacity of ASME tanks is expressed in gallons. ASME tanks are filled while the tank is attached to the motor home by a qualified propane facility. ASME tanks are equipped with an automatic stop fill valve designed to reduce the potential of overfilling. ASME propane tanks are also equipped with a P.O.L. service valve that is for connection of

SECTION 7: FUEL & PROPANE SYSTEM

the supply hose with a left hand threaded brass P.O.L. fitting from the tank service valve to the two-stage regulator. Not for use on gas grills and other low pressure devices.



NOTE:Tanks are to be installed, fueled and maintained in accordance to State and Local codes, rules, regulations or laws.

Propane is a true gas compressed into a liquid form. As the fuel is released from the container, it changes to vapor which is then used for the operation of the appliances. Propane will not run through the appliances in the liquid state.

Propane expands 1½ percent for every ten degrees of increase in temperature. It is imperative to leave sufficient space inside the container to allow for natural expansion of gas during warmer weather.

The main shut off valve must be kept closed at all times unless you are using the propane system or filling the propane cylinder. When the cylinder is disconnected from the hose, install the valve cover that is attached to the container.

Close the propane cylinder main shut off valve by hand tightening only. Use of tools createto over tighten the valve (damaging the interior seals on the cylinder valve seat). If this type of damage occurs, the cylinder will not close properly.

This propane label should be kept permanently affixed to your RV.

Servicing or Filling

Have the recreation vehicle checked for leaks at the connections on the propane system soon after the purchase and the initial filling of each propane cylinder.

When you have a new cylinder filled for the first time, make sure your propane supplier purges your new cylinder of trapped air. Otherwise, an improper mixture of gas and air will make it impossible to light your propane appliances.

No one should be inside and only the qualified propane service technician should be near the RV while the propane tank is being filled. The new propane container must be carefully purged for best performance and must **NEVER BE OVERFILLED**. This “shut off for re-fueling” label should be kept permanently affixed to your RV.

The position of the propane container(s) and the hoses are critical to proper operation and propane flow. Follow these instructions to make sure your propane container(s) are connected properly.

WARNING
THIS SYSTEM IS DESIGNED FOR USE WITH PROPANE ONLY.
DO NOT CONNECT NATURAL GAS TO THIS SYSTEM.

BEFORE TURNING ON PROPANE:

- (A) BE CERTAIN APPLIANCES ARE CERTIFIED FOR PROPANE AND ARE EQUIPPED WITH CORRECT BURNER ORIFICES.
- (B) MAKE CERTAIN ALL PROPANE CONNECTIONS ARE TIGHT BY TESTING WITH SOAPY WATER. ALL APPLIANCE VALVES ARE TURNED OFF AND ANY UN-CONNECTED OUTLETS ARE CAPPED.

AFTER TURNING ON PROPANE:

- (A) LIGHT ALL PILOTS.
- (B) ALL CONNECTIONS, INCLUDING THOSE AT THE APPLIANCES, REGULATORS, AND CYLINDERS, SHOULD BE LEAK-TESTED PERIODICALLY WITH SOAPY WATER BY THE OCCUPANT. NEVER USE A LIGHTED MATCH OR OTHER FLAME WHEN CHECKING FOR LEAKS.
- (C) DO NOT LEAVE SYSTEM TURNED ON OR CONTAINERS CONNECTED UNTIL THE SYSTEM HAS BEEN PROVEN TO BE FREE OF ANY LEAKS.
- (D) COOKING APPLIANCES SHOULD NOT BE USED FOR SPACE HEATING.
- (E) WHEN THE CONTAINERS ARE DISCONNECTED, THE PROPANE SUPPLY LINE SHOULD BE CAPPED OR PLUGGED.

AVERTISSEMENT
CETTE INSTALLATION EST CONCEUE POUR LE PROPANE SEULEMENT.
NE PAS L'ALIMENTER EN GAZ NATUREL.

AVANT LA MISE EN SERVICE:

- (A) S'ASSURER QUE LES APPARELS SONT CERTIFIES POUR LE PROPANE ET MUNEZ-LES DE BOUTEILLES APPROPRIEES.
- (B) VERIFIER L'ETANCHEITE DE TOUTS LES RACCORDEMENTS AU PROPANE. LA FERMETURE DE TOUTS LES ROBINETS D'APPARELS ET L'OBSTRUCTION DE TOUTES LES SORTIES NON RACCORDEES.

APRES LA MISE EN SERVICE:

- (A) ALLUMER TOUTES LES VEILLES.
- (B) TOUJOURS TESTER PERIODIQUEMENT L'ETANCHEITE DE TOUTS LES RACCORDEMENTS Y COMPRIS CELUX AUX APPARELS, AUX DETENDEURS ET AUX BOUTEILLES, EN Y APPLIQUANT DE L'EAU SAVONNEUSE. NE JAMAIS SE SERVIR D'UNE ALLUMETTE OU AUTRE FLAMME POUR LA DETECTION DES FUITE.
- (C) NE PAS LASSER L'ALIMENTATION OUVERTE, NI LES RECIPIENTS RACCORDES, AVANT D'AVOIR COMPLETEMENT SPRISSE ET ETANCHEITE AU PROPANE, DE L'INSTALLATION.
- (D) LES APPARELS DE CUISON NE DOIVENT PAS ETRE UTILISES POUR LE CHAUFFAGE LOCAL.
- (E) LORSQUE LES RECIPIENTS SONT DECONNECTES, L'ALIMENTATION DE PROPANE DOIT ETRE OBTUREE OU BOCLEE.

JA-105

“Use propane only” Label (Canada only)

Label appearance may not be exact

A DANGER

ALL PILOT LIGHTS, APPLIANCES AND THEIR IGNITORS (SEE OPERATING INSTRUCTIONS) SHALL BE TURNED OFF BEFORE REFUELING OF MOTOR FUEL TANKS AND/OR PROPANE CONTAINERS. FAILURE TO COMPLY COULD RESULT IN DEATH OR SERIOUS INJURY. AD-05

“Shut off for re-fueling” Label

Label appearance may not be exact

SECTION 7: FUEL & PROPANE SYSTEM

LP Gas Container Overfill

Never allow your propane tank to be filled above the maximum safe level as indicated by the fixed liquid level gauge. Do not allow the visible gauge to be used for filling. Overfilling the propane container above the liquid capacity indicated on the container, could allow liquid propane to enter the system that is designed for vapor only creating a hazardous condition.

This label should be kept permanently affixed to your RV.

Refer to your Warranty Packet for more information on the LP gas system components.

Maintenance

Propane gas is normally non-corrosive - you need not worry about the inside of your container. However, the outside should be kept free from rust by a periodic coat of paint in a light reflective color. Rust, scratches and/or dents can affect the safety of the cylinder. Inspect the cylinder at regular intervals.

Ifs a problem, have it evaluated by a qualified technician and discard it. DOT requires that a visual inspection be made prior to each filling.

Any cylinder that has been exposed to fire, leaks or seems damaged should not be refilled.

Do not attempt to repair any containers, container valves, regulator or appliances by yourself. Use only trained certified propane gas service technicians to perform repairs.

Propane Cylinder Recertification

DOT cylinders may only be used for 12 years after their manufacture date (the number of years for certification may vary in your area). After that, the cylinders must be "recertified" which provides another five years of use.

The cylinders can be recertified every five years thereafter. Federal DOT (Department of Transportation) regulations require periodic inspections and re-qualifications of the propane cylinders. DO NOT USE damaged or rusted containers.

Verify with your local propane dealer that all required inspections and certifications have been completed on the propane cylinder within the correct time period before refilling the cylinder. Have the LP system checked for leakage each time a cylinder is refilled or after any part of the propane system has been disconnected.

Hoses, Pipes, Tubes & Fittings

The hoses, pipes, tubes and fittings used in your propane system are designed to withstand pressures exceeding those of the propane system. However, because environment and time can both contribute to the deterioration of these components, they must be inspected for wear at regular intervals.

Be sure to inspect the hose before each season and when having the tank refilled. Look for signs of deterioration such as cracks or loss of flexibility. When replacing the hose or other propane components, make sure to always replace them with components of the same type and rating (check with your dealer).

Fittings are used to connect the various system components to each other. The P.O.L. fitting at the end of the propane supply hose is made of brass so that pipe sealants are not necessary to prevent leaking.

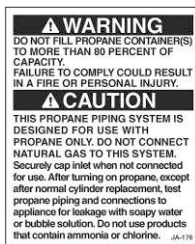

"Do not fill to more than 80%" Label

Label appearance may not be exact

It also has a left-handed thread, which means that it is turned clockwise to remove, and counter-clockwise to tighten. The P.O.L. fitting has been designed to help restrict the flow of LP gas in the event of a regulator failure or hose malfunction.

Propane Regulator

⚠ WARNING

Propane regulators must always be installed with the regulator vent facing downward. Regulators that are not located in baggage compartments have been equipped with a protective cover. Make sure the regulator vent faces downward and (if applicable) the cover is in place to minimize vent blockage that could result in excessive gas pressure causing fire or explosion.

Single stage regulator

Some models are equipped with a single stage regulator.

Two stage regulator

The two-stage regulator has the only moving components in the propane system. Its sole function is to reduce the pressure from the propane containers to a safe and consistent low operating pressure. The first stage reduces the container pressure to 10-13 lbs. The second stage reduces the 10-13 lbs. of pressure further to an operating pressure of 11" W.C. (water column) or 6.35 oz. of outlet pressure to your appliances.

The second stage is adjustable and will need to be adjusted by your dealer or qualified propane service technician for optimum performance (this adjustment should always be made with a properly calibrated manometer).

If the pressure is too high, it affects performance and safety; if the pressure is too low, your appliances will not operate correctly. If your recreation vehicle is equipped with the "automatic" two-stage regulator, with both cylinders full of propane, turn the lever on the regulator towards the cylinder you wish to use first. This will now be the "supply" cylinder and the other the "reserve." Slowly open both cylinder valves. The indicator on top of the regulator will turn bright green. When the cylinder becomes empty, the indicator will change to bright orange. Now turn the regulator lever to the side of the "reserve" cylinder and the green signal should return. You may now remove the empty cylinder to have it refilled without interrupting the flow from the full bottle. After filling the cylinder, connect the pigtail hose and slowly open the bottle valve.

PROPANE USE AND SAFETY

Propane is a colorless and odorless gas that, in the liquefied state, resembles water. An odorant (usually a sulfur compound) is added as a warning agent. If you smell propane within the vehicle, quickly and carefully perform the procedure listed on the propane system label. This label has been placed in the vehicle near the range, for models equipped with a propane system. When propane container is low, occasionally there may be a concentration of an onion or garlic-like odor, which can be mistaken for a propane gas leak. After the propane container has been refueled, the odor will usually disappear. If not, turn off the valve(s) and have the propane system inspected by your dealer or qualified propane service representative.

DANGER

IF YOU SMELL PROPANE

1. Extinguish any open flames, pilot lights and all smoking materials.
2. Shut off the propane supply at the container valve(s) or propane supply connection.
3. Do not touch electrical switches.
4. Open doors and other ventilating openings.
5. Leave the area until odor clears.
6. Have the propane system checked and leakage source corrected before using again.

Ignition of flammable vapors could lead to a fire or explosion and result death of serious injury.

Propane System Label

Propane Leak Test

Leaks may be found easily with a soapy water solution. Do not use a solution containing ammonia or chlorine when locating leaks. These products are corrosive to copper gas lines and brass fittings, which could result in deterioration of the copper and brass components.

Apply the soapy solution to the outside of the gas piping fittings. If a leak is present, the soapy solution will “bubble” at the leak point. If a leak is indicated, shut off the propane system valve(s) and contact your dealer or qualified propane service representative immediately.

DANGER

Never use an open flame to test for a propane leak. Do not check for leaks using products that contain ammonia or chlorine; these products can cause cracks to form on the metal tubing and brass fittings

Using The Propane System

Use the following steps for propane operation:

1. Close ALL burner valves, controls and pilot light valves.
2. Open the main valve in the propane tank slowly to avoid a fast rush of propane vapor through the excess flow valve causing propane “freeze-up.” Should you experience propane “freeze-up,” close the main valve and wait 15 minutes before trying again.
3. Listen carefully as propane begins to flow. If a hissing noise is heard for more than one or two seconds, close the main valve and contact your recreation vehicle dealer to have the propane system tested.
4. **Light the appliances as needed and directed in the appropriate appliance manufacturer’s owner manual located in the Warranty Packet.**

Keep the propane container valves closed at all times unless you are using the propane gas system or are having the propane container filled.

Make sure that you read and fully understand ALL safety requirements for handling and operation of the propane system.

The propane system must be handled with care. If you have any questions or concerns, consult with your dealer and/or the specific appliance manufacturer.

If you have double cylinders on your recreation vehicle, use only one at a time. Otherwise, the propane supply will be drawn equally from both cylinders until the supply has been totally exhausted. Using one cylinder until it is empty, then using the second cylinder will allow you to fill the empty cylinder at your convenience without running totally out of propane.

Cooking With Propane Gas

WARNING

- Do not turn gas range burner controls to ON and allow gas to escape before lighting.
- Do not use portable fuel burning equipment (i.e., wood and charcoal grills or stoves) inside the recreation vehicle.

Unlike homes, the amount of oxygen supply is limited due to the size of the recreation vehicle. Proper ventilation when using the cooking appliance(s) will help you avoid the danger of asphyxiation.

It is especially important that cooking appliances not be used for comfort heating, as the danger of asphyxiation is greater when the appliance is used for long periods of time. FAILURE TO COMPLY MAY RESULT IN DEATH OR SERIOUS INJURY.

These warning labels are located in the cooking area to remind the user to provide an adequate supply of fresh air for combustion.

 DANGER

Do not use gas cooking appliances for comfort heating. Can lead to carbon monoxide poisoning, which can lead to death or serious injury.

 WARNING

Gas cooking appliances need fresh air for safe operation. Before operating: Open vents or windows slightly or turn on exhaust fans prior to using cooking appliance. Gas flames consume oxygen, which should be replaced to ensure proper combustion. Improper use can result in death or serious injury.

Cooking / Comfort Heating Label

TO ENSURE A SUPPLY OF FRESH AIR TO OCCUPANTS, OPEN VENTILATORS WHEN FUEL BURNING RANGE, FUEL BURNING CARRY-ON APPLIANCE, AND/OR FUEL BURNING LIGHTS ARE IN OPERATION. COOKING APPLIANCES SHOULD NOT BE USED FOR SPACE HEATING PURPOSES.

DE MANIÈRE À ASSURER UNE ALIMENTATION EN AIR FRAIS AUX OCCUPANTS, OUVRIR LES VENTILATEURS LORSQUE LA CUISINIÈRE, LES APPAREILS DE CHAUFFAGE PORTABLES ET/OU LES LAMPES DE COMBUSTION D'HUILE SONT EN FONCTIONNEMENT. LES APPAREILS DE CUISSON NE DOIVENT PAS SERVIR AU CHAUFFAGE DES LOCAUX.

JA-110

Ensure a supply of fresh air (Canada units only)

Calculating Propane Gas Usage

Most RV gas appliances are operated intermittently, and each has a different BTU rating. You will need to consider this when planning your propane supply and consumption. Unless there is heavy use of hot water, the water heater consumption of propane is minimal. During cool temperature or high wind conditions, furnace consumption can be extremely high.

To calculate your propane supply, take the BTU ratings for your propane appliances and divide that into the BTU availability. Each gallon of propane gas (3.785 liters) produces about 91,500 BTU's (96,528 kilojoules) of heat energy.

Propane consumption chart

The following chart provides average propane consumption information.

SECTION 7: FUEL & PROPANE SYSTEM

Appliance	Average BTU Consumption per Hour	Kilojoules/Hour
Water Heater	8,800	9,280
Refrigerator	1,200 – 1,500	1,270 – 1,580
Furnace	35,000 – 40,000	36,930 – 42,200
Range/oven	7,100	7,490
Range, rear burner	6,500	6,860
Range, front burner	9,000	9,490
Outside Grill	10,000	10,550

Traveling With Propane

NOTE: Some states prohibit propane appliances to be operated during travel, especially in underground tunnels. Make sure you know the laws for the areas where you travel.

Use care when fueling your motor fuel tanks and/or propane containers. Make certain your propane tank is properly fastened in place. This label should be kept permanently affixed to your recreation vehicle.

▲ DANGER
ALL PILOT LIGHTS, APPLIANCES AND THEIR IGNITORS (SEE OPERATING INSTRUCTIONS) SHALL BE TURNED OFF BEFORE REFUELING OF MOTOR FUEL TANKS AND/OR PROPANE CONTAINERS. FAILURE TO COMPLY COULD RESULT IN DEATH OR SERIOUS INJURY. AD-05

Refueling Warning Label

INSTALLING PROPANE CYLINDER(S)

▲ WARNING

Make sure all fasteners are secured before traveling.

Single Cylinder Mounted On A-Frame (if so equipped)

1. Connect the 3/8" low pressure hose to the outlet of the two stage regulator.
2. Attach the regulator with the "Z" bracket on the center of the front wall with the vent pointing down.
3. Attach the protective plastic cover to the regulator.
4. The regulator has a 90° elbow that directs the inlet toward the trailer curbside.
5. Place the cylinder on the bracket provided on the A-frame and position it so the outlet of the cylinder valve is pointed directly outward to the curbside wall.

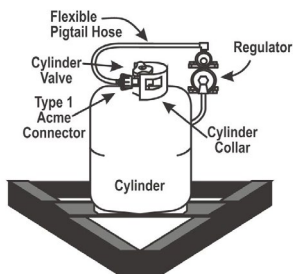

Single Cylinder

SECTION 7: FUEL & PROPANE SYSTEM

6. Attach the 1/4" inverted flare x 24" Type 1 pigtail hose to the regulator inlet and the right hand swivel nut to the cylinder valve.
7. Secure the cylinder to the A-frame bracket using the bolts, nuts and washers provided.

Double Cylinder Mounted On A-Frame (if so equipped)

When a second cylinder is installed, a tee check valve is used to replace the 90° elbow at the top of the regulator and another 1/4" inverted flare x 24" Type 1 pigtail hose is added. The regulator stays in the original position.

Place the second cylinder on the A-frame bracket so the cylinder valve is pointed to the roadside of the recreation vehicle.

1. Secure the second cylinder to the A-frame using the bolts, nuts and washers provided.
2. Attach the second 24" hose to the tee check valve on the regulator and the right handed swivel nut to the cylinder valve.

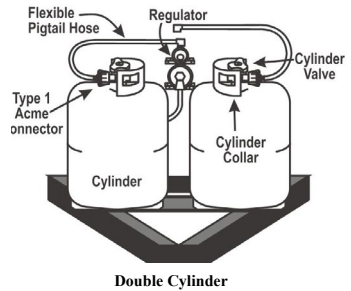

Located in a recessed compartment or housing (if so equipped)

1. Connect the 3/8" low-pressure hose to the outlet of the two-stage regulator.
2. Place the cylinder on the bracket in the recess compartment or housing and secure them so the outlets of the cylinder valves are facing the "sidewalls" of the compartment or housing (opposite of each other).
3. Mount the regulator on the center back wall of the compartment or housing so the vent is pointed downward.
4. Attach the 1/4" inverted flare x 18" Type-1 pigtail hose to the regulator inlet and the right hand swivel nut to the cylinder valve.

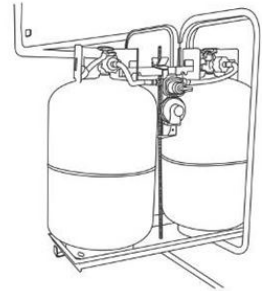

Two Propane Cylinders

Main Supply Hose – Low Pressure

Attach the main supply hose from the regulator to the brass manifold fitting in the frame of the trailer. The swivel brass nut on the main hose will be your final attachment.



Main Supply Hose

Each time the propane container is removed:

1. Check that ALL fittings are tight.
2. Check that ALL connections are tested with a propane leak detector (or soapy water) solution.
3. Open the main valve slowly to avoid a fast rush of propane to the excess flow valve causing propane freeze up. If you experience a propane "freeze-up," close the main valve and wait at least fifteen (15) minutes before trying again. Refer to the regulator manufacturer's operator manual.
4. Listen carefully - a "hissing" sound longer than one second may indicate a propane leak. If you feel there may be a leak present, close the valve and contact your dealer or qualified propane technician for repair assistance.

SECTION 7: FUEL & PROPANE SYSTEM

Replace all protective covers and caps on the propane system after filling. Make sure the valve is closed and the compartment door is securely latched.

PLUMBING SYSTEM

There are two different water systems in your recreation vehicle:

- The fresh water system consists of the fresh water holding tank, faucets and connections, water pump, outside shower assembly (if so equipped), water heater, tub/shower, and water purification system (if so equipped).
- The waste water system consists of the waste water and sewage holding tank(s), drains and toilet.

Plumbing System Maintenance

- Check all fittings, pressure and waste, for leaks before each trip or before vehicle storage as part of your normal maintenance:
- Inspect all faucets, the water purification system (optional) and sink connections (including drain baskets or filters).
- Inspect connections at the water pump and water heater.
- At the end of every trip, you should drain any unused water from the fresh water system.
- All water contains contaminant and mineral particles that can cause fresh water system odors. Untreated well water is a major source of water system odors.
- The fresh water (potable water) system needs periodic sanitization and winterization to take care of all the components within the plumbing system and help discourage the growth of bacteria and other organisms that can contaminate the water supply.

Typically, there are labels affixed to the exterior of the recreation vehicle sidewall that indicate the locations of the water system drains and fills. Be aware some drain valves may be located inside the vehicle (once the exterior label is found, go inside to find the drain corresponding location).

MONITOR PANEL

Monitor panel locations may vary by model. Typical locations are on the command center panel, on an interior wall, or on the exterior utility center.

It allows you to monitor the fresh water, grey water, black water and auxiliary battery levels. These functions are controlled using the tact switches. The monitor panel operates on 12-volt DC power supplied by either the converter or auxiliary battery. No power is drawn from the battery unless a switch is pushed or turned ON. Fuses for the monitor panel are located in the load center. Refer to the manufacturer's operators manual for additional information.



Monitor Panel

NOTE: If your RV has secondary black or gray tanks, there may also be an additional tank monitor. located elsewhere in your RV. It is typically labeled as a convenience center.

SECTION 8: PLUMBING SYSTEM

Operation

Press only one tact switch at a time. As you push either the FRESH, BLK GREY1 or GREY2 switch, one or more LED lights will illuminate (from left to right) indicating the content level for that tank. When pushing the "BATT" switch, the LED lights illuminate from left (lowest) to right (highest) to indicate the estimated auxiliary battery condition.

NOTE: When using shore power all 4 LEDs will light. If disconnected from shore power, 3 LEDs will light to indicate a full charge (4th LED may blink).

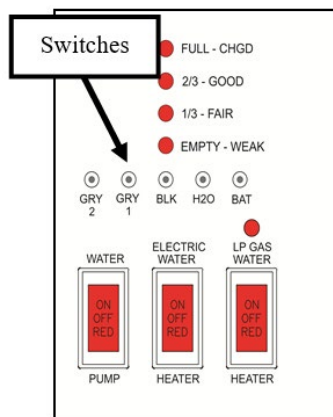

Command Center

(Monitor panel appearance and components may vary)

The LEDs on the panel indicate the following:

- C** = Charge at 12.7 volts
- G** = Good at 12.1 volts
- F** = Fair at 11.6 volts
- L** = Low at 6.0 volts

The **water pump switch (if so equipped)** may be located on the monitor panel, the utility center or both. When the water pump switch is ON (it will light up), the water pump will run until it reaches 45 lbs. of pressure. It will recycle when pressure drops. Turn the switch OFF when the water pump is not being used.

The **water heater switch(s) (if so equipped)** are located on the monitor panel, and will light up when turned on. The "LP GAS" water heater switch (12V) enables propane operation of the water heater, and the "ELECTRIC" switch (120V) enables electric operation of the water heater. Normally both switches should be turned on to provide the fastest hot water recovery time. The water heater can be operated in electric only or gas only modes by pressing each switch independently. If the RV is equipped with a tankless water heater, there will be only an LP Gas switch on the command center panel.

DSI FLT - Direct Spark Ignition Fault (if so equipped): This light located between the water heater switches will indicate a problem with the LP portion of the water heater. When the LP GAS switch is turned on, the light will blink quickly 3 times and the water heater will ignite. The light will then remain off. If the light comes on and stays on, it indicates the gas side of the water heater has not fired and there is a problem with the igniter.

WARNING

- DO NOT drink water deemed microbiologically unsafe or of unknown quality.
- Never travel with full fresh, black or grey water holding tanks.

FRESH WATER SYSTEM

All water contains contaminant and mineral particles that can cause fresh water system odors. Untreated well water is a major source of water system odors. The fresh water (potable water) system needs periodic sanitization and winterization to take care of all the components in the plumbing system to discourage the growth of bacteria and other organisms that can contaminate the water supply.

Water Pressure Regulator (customer supplied)

Excessive pressure from the water supply source may be encountered in some parks, especially in mountain regions when using the fresh water inlet or black tank flush. Water pressure regulators are available to protect your recreational vehicles plumbing system against such high pressure.

CAUTION

A water pressure regulator is recommended to prevent damage to the plumbing system or components. To prevent damage when using the city water connection, a 45 lb. (315 KPa) rated water pressure regulator is recommended.

Fresh Water Holding Tank

There may be several ways to fill the fresh water tank depending on the model. For details of each method, refer to the *Fresh Water Connections* or the *Utility Center (if so equipped)* sections. There are plastic overflow tubes in the fresh water holding tank which allow water to flow out of the water tank (see *City Water Fill*). Occasionally, you may see water coming from the overflow tubes when the fresh water holding tank is filled. This is normal and can be a result of the recreation vehicle being parked on an incline, or the motion caused by starting or stopping during travel.

CAUTION

- Do not cap, block or modify the fresh water tank overflow tubes in any way. Enough water pressure can build up during the filling process to damage the plumbing system if the overflow tubes are obstructed.
- Be careful not to overfill the fresh water holding tank. It can pressurize the tank, causing leakage and water damage and void the warranty. DO NOT leave the tank unattended while filling.

12-Volt Water Pump & Switch

When you want to use water in your recreation vehicle and it is not hooked up to city water, you will need sufficient 12-volt DC power to run the water pump.

Once activated, the water pump (also known as the demand pump) will self-prime, and provide water. The pump is designed for **intermittent use only**. Using the pump continuously or with high pressure will shorten the life of the pump and is not covered in your warranty.

Periodically check the in-line water pump strainer for accumulated debris. To clean, shut off the water pump, unscrew the clear cap, remove the re-useable metal strainer and clear any debris, then reinstall.

SECTION 8: PLUMBING SYSTEM

For additional information on the care and operation of the pump, read the safety and operating information in the pump manufacturer's owner's manual.

Water Pump Switch (if so equipped):

Most water pump switches illuminate when the water pump is activated. In most models, the (red) pump switch is located on the monitor panel or the utility center. When the water pump switch is ON the pump runs until 45 lbs. of pressure has been achieved. The red light will stay on. The water pump automatically recycles when pressure drops. Some cycling may occur depending on the volume of water being released. Turn the water pump switch OFF when it is not in use.

NOTE: In some models the water pump switch will be a black rocker switch located near the sink cabinet

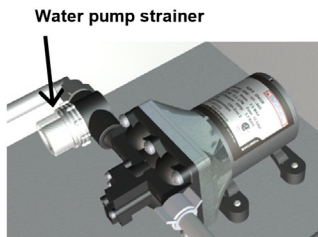

The water pump switch should be in the OFF position when the RV is left unattended for any amount of time. If something would happen to the water system, this may help limit water damage to a smaller area.

FRESH WATER CONNECTIONS

Your recreation vehicle may be equipped with one or both of the following fresh water connections: city water and gravity fill. The city water fill has a threaded connector with a city water connection label next to it. Do not remove this label.

NOTE: If needed, sanitize the water system prior to travel.

Using City Water Fill (If So Equipped)

Remove the connection cap and attach a non-toxic drinking water hose to the threaded inlet.

1. The other end of this hose should be connected to a pressurized fresh water source (such as a faucet or spigot). You should use a non-toxic drinking water hose dedicated only to supplying fresh water to the vehicle.
2. Turn ON the water at the water source. Open the cold water supply faucets to bleed air from the water lines. When the water lines are nearly full, you may experience some "air pockets." Allow these to escape before closing the cold water supply faucets.



City Water Fill with City Water Connection label



NOTE: The City Water Fill inlet when connected to a pressurized fresh water source sends water through the water lines and fixtures without the use of the pump. The fresh water tank cannot be filled using the city water fill (the gravity fill is used to fill the fresh water tank).

3. The water heater (if so equipped) will fill first, followed by the supply lines and faucets. Water heater bypass valves (if so equipped) A and B must be open to allow water into the water heater, valve C should be closed. Refer to the *Water Heater Bypass* section for an explanation on configuring the bypass valves. Bypass valves are normally located near the water heater.

The fresh water connection should be unscrewed (i.e., the non-toxic drinking water hose disconnected) when the recreation vehicle is left unattended for any amount of time. If something would happen to the water system, this may help limit water damage to a smaller area.

To Disconnect the City Water Fill

1. Shut OFF the water at the pressurized water source.
2. Disconnect the non-toxic drinking water hose and reinstall the connection cap. The connection cap should always be installed if the water fill is not in use.

Using the Gravity Fill (If So Equipped)

You can fill the fresh water tank from a container of fresh water and the gravity water fill inlet if you do not have access to City Water.

The gravity fill will have a potable water label next to it. Do not remove this label.

Low point & fresh water tank drains should be closed.

Potable Water
Label



Gravity Water Fill

1. Remove the connection cap and insert a non-toxic drinking water hose (or a funnel) into the gravity fill inlet. The other end of the hose goes into a container of fresh potable water.
2. Pour the fresh water into the gravity fill until the tank is full.
3. Open both the hot and cold water faucets, along with outside shower faucets (if so equipped) when filling the fresh water tank to allow air pockets to be forced out of the system.
4. When the fresh water tank on the RV is full, remove the non-toxic drinking hose and container from the gravity water fill. Replace the connection cap. This cap should always be installed if the water fill is not in use.

SECTION 8: PLUMBING SYSTEM

DRAINING THE FRESH WATER SYSTEM

Water tanks may be drained through a valve located near the tank. A recreational vehicle with a demand pressure pump system will have low-point drains attached to the water lines (normally located near the water tank).

These low-point drains will release water in the supply lines by opening the valves and all faucets. The water heater has its own drain plug. To drain the permanent fresh water holding tank and supply lines:

1. Turn the water heater power OFF (turn off the electric & LP GAS switches).
2. Open all faucets, including the outside shower faucet (if so equipped).
3. Open the “fresh tank drain” valve. All fresh water tanks can be drained by one of two types of drain valves. A white plastic drain is attached to the exterior wall or a valve located inside the RV adjacent to the water tank (turn 45° to open or close).
4. Open the “low point drains” by turning, then pulling the handles up. They are installed at the lowest point of the water lines. A label is placed on the outside of the RV to indicate where the drains are located. The drains will need to be operated from inside the RV. Once the label is found on the exterior sidewall, the drains will be found at a corresponding location in the interior.
5. Drain the sink by removing the drain cap.
6. Turn ON the water pump and allow it to run as needed.
7. If the RV water heater has bypass valves: Set them to the BYPASS configuration (refer to the *Water Heater Bypass* section).
8. Operate the toilet flush lever until water stops flowing.
9. Relieve the water pressure using the P&T valve BEFORE removing the water heater drain plug. If there is any water pressure present, the water will spray out of the opening when the drain plug is removed.



Exterior Fresh Water Drain

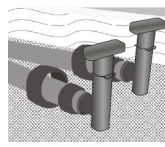

Low Point Drains

When you are finished draining the fresh water system, reverse these steps and dump the grey and black water holding tanks. It is normal for some liquid to remain in the fresh water tank after drainage procedure.

SANITIZING/WINTERIZING THE PLUMBING SYSTEM

Two Valve Water Heater Bypass

Most floor plans have a factory installed water heater bypass that enables you to avoid filling the water heater with RV antifreeze. Bypass valves are typically located in close proximity to the water heater. Outside utility centers (if so equipped) operate differently than a factory installed bypass system. Refer to the Outside Utility Center section for details.

Operation

Normal Mode operation allows water to flow into the water heater. Valve handles should be turned so they are pointing in line with the hot and cold supply lines.

Bypass Mode operation diverts the flow of water around the water heater keeping water out of the water heater. Valve

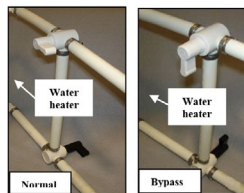

Two Valve Water Heater Bypass

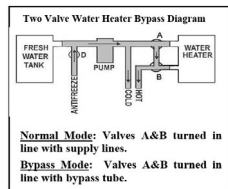

handles should be turned so they are pointing in line with the vertical bypass tube (connecting both valves together).



NOTE: In the diagram: Valve A is the black valve, valve B is the white valve.

Valve D is the suction (syphon) valve that has the clear hose attached to it for siphoning in antifreeze, sanitizer or fresh water from an external container. This valve is typically located at the water pump.

When to sanitize:

- When your recreation vehicle is new.
- At the beginning and end of each season.
- When the water system becomes contaminated or every three months of use.

How to sanitize

1. Turn water heater power OFF (storage style-both electric and LP gas switches; tank less water heater turn power switch OFF).
2. Set the bypass valves to BYPASS (refer to Water Heater Bypass Valves section).
3. Level the RV and drain the fresh water system (see Draining the Fresh Water System).
4. Close the low point drain valves and the fresh water tank drain valve.
5. If the RV has a cartridge type water filter it must be removed and bypassed using the (supplied) bypass tube. Sanitizer should never be allowed into a water filter.
6. Prepare a chlorine solution using 1/4 cup of household bleach (sodium hypochlorite solution) to one gallon (3.785 liters) of water in a container. Prepare one gallon of solution for every 15 gallons of tank capacity. This will result in a residual chlorine concentration of 50 ppm in the water system.

If a 100-ppm concentration is required, use 1/2 cup of household bleach with one gallon of water to prepare the chlorine solution. One gallon of the solution should be used for each 15 gallons of tank capacity.



NOTE: Fresh water tank sizes vary by model; contact your dealer or customer service for your specific tank size.

7. Put the sanitizer solution in the fresh water tank: Insert one end of a hose (or funnel) in the gravity fill inlet, insert the other end into a container holding the chlorine solution. Do not use your non-toxic drinking water hose. Pour the chlorine solution into the gravity fill.
8. Remove the hose (or funnel) and container used to pour the chlorine solution, and continue filling the fresh water tank with clean (potable) water until tank is full: Pour fresh water into the gravity fill inlet until tank is completely full. After the recommended amount of sanitizing solution is in the tank, the water tank is full, and water filter has been removed and bypassed, turn the pump ON which sends sanitizer into the water lines.w

SECTION 8: PLUMBING SYSTEM

9. Open all hot water faucets one by one until water begins to flow continuously and a chlorine smell is noticeable. Include outside shower faucets (if so equipped).
10. Close the hot water faucets and repeat opening all cold water faucets one by one until you smell chlorine. Include outside shower faucets (if so equipped) and toilet.
11. Turn OFF the water pump.
12. Let the solution remain in the tank & lines for at least four hours when disinfecting with 50-PPM residual chlorine. If a shorter time period is desired, then a 100-PPM chlorine concentration should be permitted to sit in the system for at least one hour.



NOTE: To thoroughly sanitize the fresh water tank, the unit should be driven around for a period of time allowing the solution to splash the sides and top of the tank

13. After the required period, drain the chlorine solution from the fresh water system. Since the water heater was bypassed there should be no sanitizer in the (storage) tank water heater.

Rinse the system with fresh water:

14. Fill the fresh water tank full of clean (potable) water. Fill fresh water tank from an external container. Pour fresh water into the gravity fill inlet using a hose (or funnel).
15. Power to water heater should be OFF. (both switches: electric & LP gas) When the fresh water tank is full: Turn the pump ON to send water through the lines.
16. Run water through all faucets (hot & cold, including outside shower) until chlorine smell is gone. Turn faucets and outside shower off, turn pump OFF.
17. Then, drain the fresh water system again (see Draining the Fresh Water System).
18. Set water heater bypass to NORMAL: Allows water into the water heater. Replace the water heater drain plug.
19. Refill the fresh water tank with fresh water again and when water heater is full of water, turn the water heater power ON. Refer back to Step 14 above for instructions on refilling the fresh water tank.



NOTE: : If a chlorine taste lingers in the water, flush the water system with a solution consisting of one-quart vinegar to five gallons of clean water. Re-flush as necessary. The vinegar solution may damage the water heater or the water filter, so both must be bypassed again before performing this operation.

Follow the steps outlined in Draining the Fresh Water System with one exception, do not drain the water heater. Water heater bypass valves set to BYPASS (Refer to Water Heater Bypass section) Do not remove the water heater drain plug.

Remove the cartridge water filter (if equipped) and replace it with the bypass tube included with your RV.

After draining the system:

1. Water heater power should be OFF. (both switches: electric and LP gas) Water heater bypass valves (if applicable): A&B should be closed, valve C open.
2. Put the vinegar solution into the fresh water tank. Pour the vinegar solution into the gravity fill using a hose (or funnel).
3. Continue filling the fresh water tank with of clean (potable) water. Pour fresh water into the gravity fill inlet using a hose (or funnel).
4. Run water through all faucets (hot and cold, including outside shower) until chlorine smell is gone. Turn the pump ON to send water through the lines.
5. Close all faucets including outside shower. Turn pump OFF.
6. Drain the system again, but don't drain the water heater. Water heater bypass set to BYPASS (refer to Water Heater Bypass). Do not remove water heater drain plug.
7. Close low point drains and fresh water tank drain.
8. Refill the fresh water tank with clean potable water. Use the gravity fill, (refer to Step 3 for specific instructions).
9. Open faucets and check that the chlorine taste is gone.
10. Drain the system one more time (See Draining the Fresh Water System)
11. Remove full system canister, insert the filter, and reattach canister to the mount. Water heater bypass valves set to NORMAL (Refer to Water Heater Bypass section).
12. Refill the fresh water system with clean water. When the water heater is full of water, turn the water heater power ON.

Winterizing The Plumbing System

Preparing your recreation vehicle for colder weather or storage is very important for most states and Canada. Failure to prepare your RV may cause water supply lines and the water heater to freeze. The RV should be winterized at the end of the camping season or when it will be exposed to temperatures that will fall at or below 32°F (0°C). Repairs due to freezing are not covered by warranty.



NOTE: The winterization process may vary slightly due to different plumbing configurations between models.



NOTE: Appliances must be winterized. Refer to the manufacturer's manual for additional information or contact Customer Service for assistance.

If you chose to perform the winterization process yourself, read and understand the following information before starting. Contact customer service or your dealer for questions about this process. It may be easier to winterize the RV with another person to assist you.

SECTION 8: PLUMBING SYSTEM

NOTE: : The water heater must be drained to prevent damage from freezing. It is recommended the water heater be drained and bypassed during the winterization process particularly if introducing RV antifreeze into the plumbing system. **Do not drain the water heater while it is hot or under pressure!** Antifreeze should be kept out of the water heater.

The preferred method to winterize your recreation vehicle is by using RV antifreeze in the plumbing system.

Air Pressure Method

This method uses compressed air to blow out any remaining water in the system after initially draining water using drain valves. Tools required would be an air compressor and a blowout plug.

⚠ WARNING

- ❑ Never apply air pressure to the water system with any of the valves in the closed position. Air pressure applied to a closed valve, faucet or low point drain could potentially damage the seals and cause water leaks. If you have questions, consult with your RV dealer. Using RV antifreeze is the preferred method of winterization.
- ❑ **Recommended pressure is 30 PSI, exceeding this pressure may rupture water line couplings and void your warranty.**

1. Turn off the water heater gas valve typically located outside the RV. Water heater power should be OFF (turn off both ELECTRIC and GAS switches).
2. Level the RV and drain the fresh water plumbing system. See Draining the Fresh Water System.
3. Water heater bypass should be OFF which will allow air to flow through the water heater. If the drain plug is still in place, it should be removed (as shown). Refer to the Water Heater Bypass section.
4. RV water filter should be removed for winterizing. Refer to Water Purification System section. Your RV may have a cartridge type water filter. Remove the cartridge filter (if so equipped), and replace it with a bypass those supplied with your RV. Antifreeze should be kept out of the water filter.

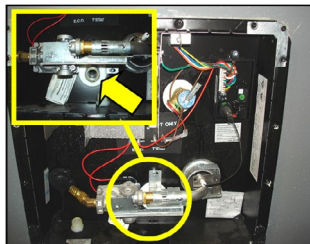

Water heater drain plug location

NOTE: Filters should be replaced at the beginning of the camping season or if they have come into contact with contaminated water or antifreeze.

SECTION 8: PLUMBING SYSTEM

5. Run the pump until it is dry (approximately 15 to 20 seconds). Operating the pump longer than that with no water can damage the pump.
6. Open all faucets in the RV. If there is an outside shower, attach the shower hose to the shower, and open the shower faucets.
7. Attach a blowout plug to the city water inlet on the outside of the RV. Refer to Fresh Water Connections.
8. Attach the air hose to the blowout plug. Set compressor to 30 PSI.
9. Fresh water tank drain should be open.



NOTE: if your RV is equipped with a water tank shutoff valve (located near the water pump) it should be opened to allow air to blow into the water tank (refer to Water Heater Bypass).

10. Blow air into the water lines through the blowout plug and the City Water Inlet to evacuate all water from the lines. Air should only be blown into the water tank for 30 to 60 seconds to avoid pressurizing the tank, then turn the water tank shutoff valve OFF. Continue blowing out the water lines which can take 5 to 10 minutes.
11. Pour one cup of RV antifreeze in all the drain P-traps (sinks & bathtub).
12. After RV water lines have been blown out, remove the air hose and the blowout plug from the City Water Inlet.



**Blowout
plug**

Winterize the Black Tank Flush (If So Equipped)

1. Connect the blowout plug to the black tank flush inlet on the outside of the RV.
2. Connect the air hose to the blowout plug. Set the compressor to 30 PSI maximum.
3. Make sure the black tank has been emptied. Open the black tank drain valve.
4. Blow air into the flush inlet for 30 to 60 seconds.
5. Disconnect the compressor and blowout plug.
6. Close the black tank drain.

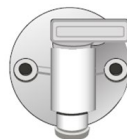

**Exterior
fresh water
drain**

Winterizing with Antifreeze Method

Requires non-toxic RV antifreeze in the water lines and does not require any special tools.

Use **ONLY** RV ANTIFREEZE in your fresh water system for freeze protection. No other product or commodity should be used.

⚠ WARNING

Automotive antifreeze (ethylene glycol) and windshield washer antifreeze (methanol) are poisonous. Never use these products in your fresh water system. These products are harmful and may be fatal if swallowed.

SECTION 8: PLUMBING SYSTEM



NOTE: Antifreeze should never enter the water heater, RV water filter, refrigerator, refrigerator water filter, or fresh water tank.

1. Turn water heater power OFF. Turn water heater gas valve (if so equipped) OFF (outside of the RV).
2. Water heater bypass should be set to BYPASS. Refer to Water Heater Bypass Diagram. Water is prevented from entering the water heater.
3. Level the RV and drain the fresh water plumbing system. See Draining the Fresh Water System.
4. Water heater should be empty after performing Step 2. Water heater bypass should still be ON (if so equipped).
5. Cartridge water filter (if so equipped) should be removed and replaced with the bypass hose included with your RV.
6. Make sure the “fresh water tank drain” and “low point drains” are closed.
7. Close the fresh water tank shutoff valve (if so equipped). Valve should be located in the vicinity of the water pump. Open siphon valve on the water pump with the clear hose attached and insert the opposite end of the clear hose into a container of RV antifreeze solution. Valve should be located in the vicinity of the water pump. See Water Heater Bypass section.
8. Turn the water pump ON. Antifreeze will be drawn into the water lines.



NOTE: In order to create a suction all low point drains must be closed.

9. Open the hot water faucets, including outside shower (if so equipped) until RV antifreeze begins to flow continuously.
10. Close the hot water line faucets and outside shower and repeat with the cold water line faucets. Hold open the lever on the toilet until antifreeze runs into the bowl.



CAUTION

Water can accumulate in the flexible hose and dump connector of the macerator system. When winterizing the RV, antifreeze must be added to the macerator system.

Winterize the Macerator System (if so equipped)

The macerator system can retain water in the flexible hose and dump connector attached to the flex hose. Pour antifreeze into the dump connector and into the 1-1/2 inch flexible hose. Raise the hose allowing the antifreeze to run back down to the macerator pump. Return the flex hose and dump connector to the storage box.

When you are done adding RV antifreeze:

11. Turn the water pump OFF. Turn siphon valve OFF. Remove the clear hose from the container of RV antifreeze. Leave the water tank shutoff valve closed to keep antifreeze out of the fresh water tank. See Water Heater Bypass Diagram.
12. Pour 1 cup of RV antifreeze into the sink drain P-trap.
13. To prevent staining, wipe the RV antifreeze out of the sinks, shower (or tub) and toilet using a soft, dry cloth.



NOTE: In the spring when flushing antifreeze out of the water lines make sure to turn the water tank shutoff valve back ON. After flushing out water lines the water filter should be re-installed.

De-winterize the macerator system: Emptying the black tanks in the spring will flush antifreeze out of the macerator system.

WATER HEATER

The water heater manufacturer has preset the sensing limit to maintain the water temperature when the water heater is activated.

⚠ WARNING

- Hydrogen gas may result if you have not used the water heater for two weeks or more. **HYDROGEN GAS IS EXTREMELY FLAMMABLE.** To reduce the risk of injury under these conditions, open the hot water faucet for several minutes at the kitchen sink before you use any electrical appliance connected to the hot water system. If hydrogen is present, you may hear what sounds like air escaping through the pipe as the water begins to flow. Hydrogen gas may be present even after water has been drained from the water heater tank. Open the faucet at the sink and allow the system to vent for five to ten minutes. Do not smoke or have any open flame near the open faucet while venting. On DSI water heater models, make sure the switch is OFF.
- Do not alter the operation or change the design/construction of your water heater. For your safety, only factory authorized parts should be used on your water heater. Accessories marketed for recreation vehicles, such as an “add-on” electric heating elements, are not recommended by the manufacturer. Such items are not approved to be installed and could create an unsafe condition and will void all warranties
- If you smell propane gas then STOP!** and follow the procedures listed in the *Propane System* section before attempting to operate the water heater.

Operating Instructions:

Read the safety and operating information provided in the manufacturer’s manual before attempting to activate the water heater.

SECTION 8: PLUMBING SYSTEM

Make sure the water heater is filled with water before use as even momentary operation of the water heater without water in it may result in damage to the tank heating element and/or controls. **Double check the bypass valves**, make sure they are set properly.

Always open both the hot and cold water faucets when filling the fresh water tank to allow air pockets to be forced out of the water heater.

Water heater switch (if so equipped)

The “propane GAS” switch enables propane operation of the water heater, and the “ELECTRIC” switch enables electric operation. Switches are typically located on the monitor panel. For detailed information, refer to the *Monitor Panel* section.

Water heater-pilot light (if so equipped)

This water heater is gas only with a pilot ignition. The water heater controls are typically located in an outside compartment, and is ignited manually from the outside of the vehicle. Hot water will be available in approximately 30 minutes.

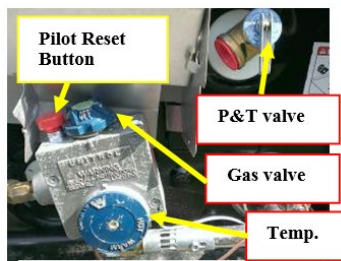

Water Heater pilot ignition

Refer to the water heater manufacturer’s manual for detailed lighting instructions.

Odor from the hot water system

Many water supplies contain sufficient amounts of sulfur to produce an odor, often called “sulfur water”. Sulfur water can be caused by a chemical action or by bacteria. Generally, sulfur water is not harmful, only unpleasant to smell. Refer to the water heater manufacturer’s owner’s manual for details on eliminating the odor from sulfur water. Odor from sulfur water is not a service problem.

⚠ WARNING

Do not replace anode rod or any other component with an accessory part that is not authorized by the water heater manufacturer, such as an “add-on electric heating element. Such items are not approved to be installed and could create an unsafe condition and will void all warranties

Anode rod protection

NOTE: Depending on your water heater manufacturer, your water heater may or may not have a replaceable anode rod. Check your water heater manufacturer documentation or contact your RV customer service department.

The tank in the water heater is protected by a magnesium or aluminum anode to prolong the life of the tank by absorbing the corrosive action of hot water. Under normal use, the anode rod will deteriorate and because of this, the water heater manufacturer recommends the anode rod be replaced yearly. Water with high levels of iron and/or sulfate will increase

the rate of deterioration; therefore, more frequent replacements may be required.

If an anode rod is mostly eaten away, replace it with a new one. The water heater manufacturer recommends replacement of the anode rod when consumption or weight loss is greater than 75 percent.

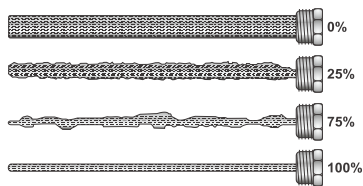

Anode rod replacement chart

Operating the water heater without the proper anode rod protection will decrease tank life and will void the tank manufacturer's warranty on the tank. To extend the anode life, drain the water from the water heater tank whenever the RV is not being used. Avoid any extended time of non-use with water in the tank.

To prevent a water leak when replacing the anode rod, a pipe thread sealant approved for potable water (such as Teflon Tape) must be applied to the threads of the anode rod. Proper application of a thread sealant will not interfere with the anode.

High Altitude Deration

Operation of the water heater at high altitudes may require derating. If the water heater is not properly derated, lack of sufficient oxygen for combustion may produce improper burner operation. Pilot outage caused by burner lift-off or sooting from a yellow burner may occur, indicating the possibility of carbon monoxide. You may also notice a lack of efficiency in heating the water because of incomplete combustion of the burner at these higher altitudes. Consult with the local propane company, your dealer or the water heater manufacturer for proper derating of the water heater. Change out of the orifice (derating) should be done by the dealer or a qualified service agency.

NOTE: It is important that once the RV has returned to lower elevation (below 4500 feet) any high altitude deration or other adjustments be reversed for proper operation of the water heater.

Pressure and Temperature Relief Valve

The temperature and pressure relief valve is designed to open if the temperature of the water within the heater reaches 120° F, or if the water pressure in the heater reaches 150 pounds. When this pressure is reached, the pressure relief valve will open and water will drip from the valve.

This “weeping” or dripping will continue until the pressure is reduced to below 150 pounds, and the valve closes. This condition is normal and does not indicate a defective relief valve.

One way to reduce the frequency of this occurrence is to maintain an air pocket at the top of the water heater tank. This air pocket will form in the tank by design; however, it will be reduced over time by the everyday use of your water heater. To replenish this air pocket:

1. Turn off the water heater.
2. Turn off the cold water supply line.
3. Open a faucet in the recreation vehicle.

SECTION 8: PLUMBING SYSTEM

4. Pull out the handle of the pressure relief (P&T) valve and allow water to flow from the valve until it stops.
5. Release the handle on the P&T valve - it should snap closed.

Close the faucet and turn on the cold water supply. As the tank fills, the air pocket will develop. Repeat this procedure as often as needed to reduce the frequency of the weeping P&T valve.

WARNING

Do not place a valve between the pressure and temperature (P&T) valve and the tank. Do not remove or plug the relief valve under any circumstances.

Maintenance

Do not allow the burner to burn with a yellow flame, or continue to operate the water heater with an improper burner flame.

Periodically, inspect the water heater vent for soot. Soot is a sign of incomplete combustion and must be corrected before operating the water heater. This is your visual warning that the water heater is operating in an unsafe manner. If soot is present, immediately shut the unit down and contact your dealer or a qualified service agency.

Periodically inspect the vent for obstructions. Do not terminate the vent on your water heater inside of add-on rooms, screen porches or patios. Doing so will result in products of combustion being vented into the rooms or occupied areas.

Draining and Winterization:

If the recreation vehicle is to be stored over the winter months, the water heater must be drained to prevent damage from freezing. Damage to the water heater caused by freezing is not warrantable. It is recommended the water heater be drained and bypassed during the winterization process, **particularly if introducing RV antifreeze into the plumbing system. Never drain the water heater when it is HOT or UNDER PRESSURE.**

To drain the water heater:

1. Turn off electrical power to the water heater either at the switch from the electrical element of at the breaker.
2. Shut off the propane supply to the water heater.
3. Turn off the pressure pump on the water system.
4. Open both hot and cold water faucets.
5. Remove the anode rod from the tank.

For detailed information, see the *Winterizing The Plumbing System* and *Water Heater Bypass* sections of this manual.

OUTSIDE SHOWER (IF SO EQUIPPED)

A handheld shower assembly with both hot and cold water may be included for use outside of your recreational vehicle.

1. Be sure the water heater is ON and had sufficient time to heat the water.
2. Open the outside shower compartment door.
3. If dry camping, be sure the 12-volt water pump is ON.
4. Remove the handheld shower from its holder.
5. Turn ON the hot and cold faucet knobs, and adjust the water temperature as desired.

6. To activate the handheld shower turn ON the sprayer head attachment (some models). To turn off the water, **always** close the hot/cold control (faucet) knobs. The lever on the shower head will not completely stop the flow of water; this is intentional to allow for draining. After the water has been allowed to drain from the shower head, return it to the outside shower compartment. Any remaining water in the shower hose will drip or run out; this is not a leak but performs as intended. If you are dry camping, turn the water pump OFF.

Turning off the water with the shower head lever can also create a condition where the hot and cold water will mix through the outside shower faucet, thereby reducing the temperature of the hot water. It can appear as though the hot water heater is not working properly.

MACERATOR PUMP SYSTEM (IF SO EQUIPPED)

Your RV may be equipped with a macerator pump system used to discharge waste from the gray and black waste tank. The system has a 1-1/2 inch diameter flexible hose that runs from the pump (under the RV) and is stored in an exterior storage compartment. The system when powered on can discharge waste (uphill if necessary) up to a distance of 150 feet.

⚠ WARNING

Before operating the macerator pump, make sure the external dump hose is properly attached at the RV and at the dump station. The hose is under pressure and therefore waste is discharged under pressure. **Failure to follow instructions can lead to possible injury or property damage. The use of this system for anything other than intended will void the warranty.**

⚠ CAUTION

Water can accumulate in the flexible hose and dump connector of the macerator system. When winterizing the RV, antifreeze must be added to the macerator system. Refer to the *Winterizing* section.

Open the hose compartment and pull out the 1-1/2 inch flexible hose (which can extend to 21 feet) with the attached dump connector. The dump connector includes two connections: a small removable cap for attaching a 3/4 inch garden hose, and a larger 3-inch removable cap that allows it to attach to the sewer outlet at the dump station.

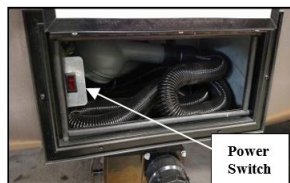

Macerator hose and dump connector

Using the system:

1. To make drainage easier, level the RV.
2. Attach the dump connector to the 3-inch sewer outlet at the dump station (Fig A), or to a 3/4-inch garden hose and run the hose to a dumping location.
3. Open the black tank dump valve.
4. Turn the Macerator power switch ON (switch lights up red) at the hose storage compartment and the macerator pump will begin sending waste through the dump hose.



Garden hose connection

SECTION 8: PLUMBING SYSTEM

5. When the tank is empty, turn the macerator power switch OFF. Close the black tank valve.
6. Select the gray drain valve.
7. Turn the Macerator Power Switch ON.
8. When tank is empty, turn the macerator power switch OFF. Close the gray tank valve.
9. Unhook the dump connector, rinse it out and replace the hose and connector back into the storage compartment.
10. The black tank flush inlet can be used with this system also (refer to the *Black Tank Flush* section).



The **Macerator Bypass Valve** is located underneath the external hose storage box. This bypass will allow you to gravity dump the waste from the tanks straight down to a 3-inch sewer hose connection under the trailer, in the event there is a problem with the macerator motor.

NOTE: The bypass valve also doubles as an emergency cutoff in the event of a problem with the flex hose or dump connector. Closing the valve stops waste flow out of the macerator pump and up to the flex hose, but will divert waste to the main dump connector under the RV. Make sure the main dump gate valve is closed until you are ready to empty the black tanks..

To operate:

1. Attach a 3-inch sewer hose to the main dump connector under the trailer and to a sewer outlet at a dump station.
2. Open the desired black / gray (manual) drain valves, one at a time (black then gray).
3. The macerator bypass valve will be pointing away from you and is attached to the macerator pump. The valve access is by design to prevent accidentally turning it off if the system is running normally.
4. The bypass valve is normally open (handle is pulled OUT). To bypass the macerator, push the bypass valve IN (turns off flow from the macerator pump) allowing waste to flow out of the dump connector under the trailer via gravity.
5. When finished, close the main dump gate valve under the trailer, along with the black / gray dump valves. Disconnect the sewer hose from the main dump connector and at the dump station.

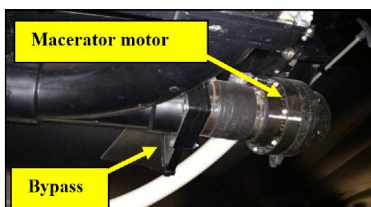

Macerator Bypass Valve

FAUCETS

The bathroom, kitchen and outside shower faucets operate much the same way as the faucets in your home. Make sure there is sufficient water available and the 12-volt water pump is turned ON before operating.



NOTE: There may be air in the water plumbing lines which needs to be bled out before a steady stream of water comes from the faucet.

BATHROOM TUB / SHOWER

Keep the water heater and holding tank capacities in mind when using the fresh water system. The used water will drain through the plumbing pipes into the grey water holding tank.

- Be sure the water heater is ON and had sufficient time to heat the water.
- If dry camping, be sure your 12-volt water pump is ON.

WARNING

Water temperatures over 125°F (49°C) can cause severe burns instantly therefore, be careful when using hot water. **Always test the water temperature before showering or washing.**

Unlike your home, the recreational vehicle does not contain a water pressure balance valve. If someone is using the shower, it is recommended that the fresh water system **NOT BE USED** until they are finished.

The shower faucet includes a vacuum breaker for the shower. There are two purposes for this breaker:

- To prevent siphoning water through the hose from another fixture.
- To prevent water from being retained in the hose.

The showerhead DOES NOT have a complete shut-off valve (the complete shut-off is at the faucet). The showerhead may drip slightly in the OFF position after use; this is normal and does not indicate a leak or defect.

Maintenance

Refer the manufacturer's user guide or label instructions for detailed cleaning information. The tub/shower walls are made of ABS plastic material. Use a mild detergent soap and warm water to clean. Do not use gritty or abrasive particle soaps or scouring compound to clean ABS plastic. Avoid using "Citrus" or biodegradable cleaners which contain "D-Limonene." They will damage plastic materials. Contact your dealer for repair or replacement.

BLACK/GREY WATER SYSTEM AND TANKS

Water from the sinks and shower flows into the gray water (or waste water) holding tank. Water from the toilet will flow into the sewage (or black water) holding tank (see *Black/Grey Water Holding Tanks*).

Drain Pipes with P-Trap (if so equipped):

The drain pipes may be equipped with a "P-trap" installed to help prevent odors from escaping into the RV. During travel, water from the P-traps may spill and permit odors into

SECTION 8: PLUMBING SYSTEM

the RV. By adding water and using a RV approved deodorizing agent you will dissolve the contents faster and will keep the drain lines and tanks clean and free flowing. These chemicals are available at an RV supply store or your dealer.

Drain Pipes with Dry Sealing Valve (if so equipped):

Your RV may be equipped with a dry sealing valve that prevents the escape of odors from your waste system and eliminates the need for P-traps. Should the RV drain piping system become clogged and a mechanical cleanout tool is used to open the drain pipe, it is important that the dry valve be removed before passing the cleanout tool through the piping. Passing a mechanical cleanout tool through the waterless valve may cause damage to the internal seal that may potentially allow sewer gases to escape into the RV interior. The waterless trap can be unscrewed from the water lines. A label has been placed near the location of the waste valve that reads as follows:

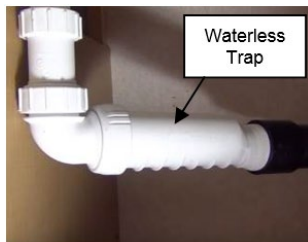

**REMOVE WATERLESS TRAP BEFORE
USING MECHANICAL DRAIN – CLEANING DEVICES**

Sewer Hose Storage:

Depending on your RV model, the sewer drain hose may be stored in an exterior compartment marked “Sewer Hose” or it may be located in the hollow square tube bumper. The bumper has removable plastic end caps, and the hose slides inside the hollow bumper.

Vents:

Another important part of this system is the vent pipes and vents that release air from the grey and black water holding tanks. On most models the exterior vent cap is attached to the roof and must be kept clear of obstructions to perform as intended. On some models, the vent pipe may be part of the drainage system referred to as a “wet vent” (water flows downward as air flows upward in the same pipe).

CAUTION

Keep drain valve closed to minimize the presence of sewer gases.
Sewer gases may be present when RV is connected to campground sewage hookup.
May lead to illness or personal injury.

Some models are equipped with a side vent system. On these models this label will be next to the termination valve. This label should not be removed from your recreation vehicle.

Black/Grey Water Holding Tanks

Dump the gray and black water holding tanks before traveling to avoid carrying unnecessary weight. The weight of the holding tank contents is not calculated into the RV cargo carrying capacity (this extra weight would reduce your available cargo capacity). Traveling with full holding tank(s) could possibly cause you to exceed the individual tire ratings and/or the RV GAWR or RV GVWR. Potential damage to suspension components, such as springs, tires and axles, could result.

If you are dry camping and cannot immediately empty your holding tanks, reduce your vehicle speed until you reach a dumping station. When connected to the sewer drain line at a campground, keep the “black tank drain” valve closed until the holding tank is at least $\frac{3}{4}$ full. This will provide sufficient water to assist in complete draining of the black water holding tank. Repeat as needed.

⚠ WARNING

Never travel with full black or grey water holding tanks. This not only wastes your fuel but depending on the location of the tank(s), it can affect your tow vehicle handling characteristics.

⚠ CAUTION

- Never leave the black tank drain in the open position continuously when connected to the campground sewer system. Leaving the drain open will allow the liquid to drain out increasing the potential for a blockage in the tank. Keeping the drain in the closed position will prevent debris from accumulating in the tank.
- Do not add automotive antifreeze or caustic chemicals, such as laundry detergents, into the holding tanks. Although these products may have a deodorizing effect, they may damage the plastic and rubber parts of the plumbing system or the components

Before using the recreation vehicle, or after dumping the grey and black water holding tanks, always add the proper amount of deodorant to the black water tank to prevent odors and help break down holding tank contents (unless winterizing). Follow the deodorant bottle or package instructions. Driving to a disposal site will normally loosen any accumulated waste debris or solids from the sides of the holding tanks.

BLACK & GREY TANK DRAINS

There are labels on the exterior of the recreation vehicle indicating the location of the grey and black tank drains (also called dump valves). Always drain the black water holding tank first so the following grey tank waste water can help rinse any solids or debris from the dump outlet and sewer hose.

To make drainage easier, level the RV.

1. Remove the sewer hose housing dust cap, and attach the sewer hose (customer supplied).
2. Place the end of the sewer hose into the approved dump station.
3. Open the black tank dump valve (depending on your model the valve may be located under the RV, or on the utility center). Close the dump valve when the black water holding tank is empty.
4. Open the grey tank dump valve (depending on your model the valve will be located under the RV or on the utility center). Close the dump valve when the grey holding tank is emptied.
5. Remove, clean and store the sewer hose.
6. Close the sewer hose housing dust cap.



Black/Grey Tank Drain & Valves

You can locate many dump stations throughout the United States and Canada in Woodall's, Rand McNally Camp Guide, Good Sam Camp Guide, KOA Campgrounds Camp Guide and various other publications. Some fuel stations also have dump stations.

Please contact your RV dealer for assistance in the purchase and installation of a sewer hose or sewer hose extension (if needed).

SECTION 8: PLUMBING SYSTEM

Sewage (black) tank preparation:

⚠ WARNING

It is important to add enough water to prevent solid waste buildup. Follow the directions listed below and in the manufacturer's operator manual.

1. Release one to two quarts (1 or 2 liters) of water into the toilet bowl.
2. Follow the directions on your (RV approved) toilet chemical bottle (customer supplied), by placing the recommended quantity of holding tank chemical into the toilet bowl.
3. Flush the toilet and allow at least two gallons (8 liters) of water to flow into the holding tank.

Waste (grey) holding tank preparation:

No special preparation is required, however, placing a small quantity of chemicals into this tank, such as baking soda or an approved RV chemical, will reduce odors from food particles in the system.

Cleaning & Maintenance:

The toilet should be cleaned regularly for maximum sanitation and operational efficiency. Use only RV approved chemicals. Do not use chlorine (undiluted) or caustic chemicals, such as laundry bleach or drain opening types, in the toilet system. These products damage the seals in toilets and dump valves.

BLACK TANK FLUSH (IF SO EQUIPPED)

The black tank flush (no fuss flush) inlet is typically located on the utility center panel. The location may vary depending on your model. The inlet color may be either white or black. Attach a garden hose (connected to a pressurized fresh water source) to the black tank flush inlet. The water goes directly into the black water holding tank sprayer connection, allowing you to remove debris and preventing accumulation. There is a check valve in the plumbing lines to prevent back flow. Flush the black water tank each time the grey and black water holding tanks are dumped or as needed.

1. Dump the black water tank (see *Gray Tank Drain & Black Tank Drain*) and leave the black tank drain valve open.
2. Connect a garden hose from the water supply source to the black tank flush.
3. With the water source turned ON, flush the black water holding tank until the water running out of the black tank drain valve is clear (not discolored or cloudy).
4. Disconnect the garden hose and close the black tank drain valve. Fasten the sewer hose housing dust cap back on the tank flush inlet.



Tank Flush Inlet

⚠ CAUTION

- The black tank drain valve must be OPEN any time there is a hose (water supply) connected to the black tank flush.
- Do not leave any hose (water supply) connected to the black tank flush when it is not in use.

⚠ WARNING

Do not use the same hose to fill your fresh (potable) water tank that is used for the black tank flush.

TOILET

The toilet is efficient and easy to operate. Prior to using the sanitation system, it is strongly recommended to flush the toilet several times to release sufficient water into the holding tank. Generally, more water is required only when flushing solids.

The toilet system will perform better when water is run for ten to fifteen seconds after flushing to ensure that the waste will proceed to the bottom of the tank.

⚠ CAUTION

- It is important to prevent solid waste buildup. Follow the toilet manufacturer's recommended instructions each time after emptying the black water holding tank.
- To prevent help toilet blockage, always use RV grade single-ply toilet paper. Do not flush paper towels, diapers, sanitary napkins or other foreign objects down the toilet.
- Do not use chlorine (undiluted) or caustic chemicals, such as laundry bleach or drain opening types, in the toilet system. These products damage the seals in toilets and dump valves.

If there is not a sufficient amount of water used during flushing, the waste materials may not evacuate properly from the drain line to the tank. Clogged tanks and pipes could eventually occur. For added convenience and better sanitation system performance, it is advisable to always have four to six inches (10 - 15 cm) of water in the toilet. It is important to add enough water to prevent solid waste buildup. The following guidelines will help to prevent solid waste buildup.

Sewage (black) tank preparation

1. Release one to two quarts (1 or 2 liters) of water into the toilet bowl.
2. Follow the directions on your (approved RV) toilet chemical bottle (customer supplied), by placing the recommended quantity of holding tank chemical into the toilet bowl.
3. Flush the toilet and allow at least two gallons (8 liters) of water to flow into the holding tank.

Cleaning & Maintenance

The toilet should be cleaned regularly for maximum sanitation and operational efficiency.

For detailed information refer to the manufacturer's operator manual.

SECTION 8: PLUMBING SYSTEM

Notes:

AIR CONDITIONER

The air conditioning system is controlled by a thermostat. Cooled air enters the RV through the grill. Make sure you have sufficient power available before operating the air conditioner. Do not operate the air conditioner without the return air filter. Operating the system without the filter allows the lint and dirt that is normally stopped by the filter to accumulate on the cooling coil of the air conditioner. This also will lead to a loss of air volume, possible equipment damage and an expensive cleaning process.

Roof Mount (if so equipped)

A special foam gasket is placed between the roof material and the subframe of the air conditioner to guard against water leakage. The air conditioner is subjected to wind pressures along with motor vibration during normal operation. Inspect the mounting bolts for tightness to ensure there is no leakage or looseness at least annually. Re-tighten bolts when they are loose. DO NOT over tighten these bolts as it may damage this gasket. The air conditioner gasket is a wearable part that eventually will need to be replaced. To gain access to the bolts, remove the filtered panel cover on central air systems or the entire air box on non-central air conditioners.

Wall Mount (if so equipped)

Keep the air inlet grill and cabinet clean by wiping with a cloth dampened with warm water and a mild detergent.

Heat Pump Operation (if so equipped)

Set the thermostat for either electric or gas heat. On the electric setting, the heat pump will become the primary heat source as long as the interior temperature of the RV has not dropped 5° below the thermostat set point. If this occurs, the thermostat will automatically activate your gas furnace.

The furnace will continue as the heat source until the thermostat set point has been satisfied. At that point, the heat pump will again become the primary heat source.

For additional information refer to the manufacturer's owner's manual included in your warranty packet or consult your dealer.W

POWER ROOF VENT (IF SO EQUIPPED)

The 12-volt DC attic fan (or powered roof vent) allows fresh air to circulate through the recreational vehicle. Do not leave the attic fan open when the recreational vehicle is stored or unattended for long periods.

High winds, other unusual conditions or obstructions may prevent the dome from closing; the resulting leakage could cause non-warrantable damage.

To use your fan most effectively, close all vents and slightly open a window on a shaded side of your recreation vehicle. You are directing the air flow by opening a window.

For additional safety and operating information refer to the manufacturer's owner's manual.

Control pad (if so equipped)

The attic fan may be controlled by a control pad. The dome can be raised or lowered with the UP/DOWN buttons, and the speed of the fan is controlled by the ARROW buttons. It is also equipped with a rain sensor that will close the vent automatically when it rains. The rain sensor can be turned on/off by holding the DOWN button for 3 seconds.

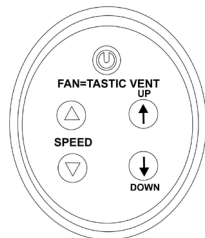

Attic Fan Control

SECTION 9: HEATING & COOLING

FURNACE

The furnace installed in your recreation vehicle is controlled by a 12-volt DC thermostat. Depending on your model, there may be up to two thermostats enabling you to control the temperature to your comfort level.

The furnace requires both 12-volt power and propane gas for full operation. Make sure you have sufficient power available before operating your furnace.

If you have any questions contact your dealer or Customer Service. A qualified RV technician should perform all furnace maintenance at least once a year (more often depending on furnace usage). Never attempt to repair the furnace yourself.

Ducting & Return Air

All heat discharges, registers and return air grills must be free and clear of obstructions. This includes all closeable registers that are intended to reduce airflow, do not shut it off completely.

WARNING

- The furnace should be inspected periodically (monthly during the heating season) for presence of soot on the vent. Soot is formed whenever combustion is incomplete. This is a visual warning that the furnace is operating in an unsafe manner. If soot is observed on the vent, immediately shut the furnace OFF and contact a qualified service agency. Operating the furnace under this condition could lead to serious property damage, personal injury or loss of life.
- To ensure your personal safety, do not obstruct or alter the furnace in any manner. Do not install screens over the vent for any reason. Screens will become restricted and cause unsafe furnace operation. For your safety, only the manufacturer's factory authorized parts should be used on your furnace.

MICROWAVE

CAUTION

- To prevent damage, remove the turntable from the microwave when traveling.
- Make sure you are connected to a 120-volt power source.

WARNING

Never use the microwave cavity for storage. The microwave cavity should always be empty when not in use.

For details on operation, cleaning and safety information, refer to the manufacturer's user guide.

General Cleaning Microwave and Convection Microwave

IMPORTANT: Before cleaning, make sure all controls are off and the microwave oven is cool. Always follow label instructions on cleaning products.

To avoid damage to the microwave oven caused by arcing due to soil buildup keep cavity, microwave inlet cover, cooking rack supports, and area where the door touches the frame clean.

Clean with mild soap, water and a soft cloth or sponge, or as indicated below.

- Grease filters: mild soap and water or dishwasher.
- Door and exterior: mild soap and water, or glass cleaner applied to paper towel.
- Control panel: sponge or soft cloth and water.
- Stainless steel (on some models): mild soap and water, then rinse with clean water and dry with soft cloth, or use stainless steel cleaner.
- Turntable: mild soap and water or dishwasher.
- Rack(s): mild soap, water and washcloth. Dishwasher cleaning is not recommended.

Convection Microwave (if so equipped)

The convection microwave bridges the gap between microwaving your food and conventional cooking. Make sure there is sufficient 120-volt power before operating the convection microwave (see *Calculating Electrical Load*). or details on operation and safety information, refer to the manufacturer's user guide.

COOKING SAFETY

In Case Of a Grease Fire

WARNING

Do not attempt to use water to put out the fire. Water can spread some types of fire, and electrocution is possible with an electrical fire.

Grease is flammable. Never allow grease to collect around top burners or on the cook top surface. Wipe up spills immediately. Refer to Section 2 – Safety Precautions, for fire safety and fire extinguisher information.

Cooking With Propane (if so equipped)

See the *Propane System Section* for important safety instructions. Refer to the manufacturer's owner's manual for detailed operating and safety instructions for all propane appliances.

COOKTOPS; RANGE & OVEN (IF SO EQUIPPED)

For detailed operating and safety information, refer to the manufacturer's user guide.

⚠ WARNING

- During and after use, do not touch or let clothing or other flammable material come in contact with the top burners (or heating elements), burner grates or other areas near the top burners or oven until they have had sufficient time to cool. These areas can get hot enough to cause burns.
- Never leave cooking food unattended. Turn pan handles inward, but not over the tops of the other range burners. Ensure that pans used are large enough to contain the food and avoid boil-overs. Heavy splattering or spills left on the cooktop can ignite and cause burns.
- If using glass, glass/ceramic, ceramic, earthenware or other glazed utensils (or cookware) verify it is safe for use on the top burners. Only certain types of utensils (or cookware) are suitable for surface or top burner use.
- Do not cover the oven vent openings while the oven is in operation.** Restricting the flow of combustion air will create an asphyxiation hazard.

⚠ CAUTION

Never use oven cleaners, chlorine bleach, ammonia or glass cleaners with ammonia. Always allow the cooktop to cool before cleaning.

Cleaning instructions

Refer to the manufacturer's user guide included for detailed cleaning instructions.

General Cleaning

- To avoid damage and possible burns, be sure the appliance is off and all parts are cool *before* handling or cleaning.**
- Use care to avoid steam burns if a wet sponge or cloth is used to wipe spills on a hot surface.
- Some cleaners can produce noxious fumes if applied to a hot surface.
- To prevent staining or discoloration, clean appliance after each use.
- If a part is removed, be sure it is correctly replaced.
- If a spillover occurs while cooking, immediately clean the spill from the cooking area while it is hot to prevent a tough cleaning chore later. Using extreme care, wipe spill with a clean, dry towel.

Electric Drop-In Cooktops (if so equipped)



NOTE: Make sure you are connected to a 120-volt power source.

 CAUTION

Do not use aluminum foil on the electric range cooktop, as this material will damage the cooktop surface if it melts. Do not use aluminum foil under any circumstances on the electric range cooktop.

Gas Drop-In Cooktops (if so equipped)

Depending on your model, it may be equipped with either a 2 burner or 3 burner cooktop. The 2 burner match-light cooktop has two 6500 BTU/H burners with control panel.

The 3-burner piezo-igniter cooktop has (1) front 9000 BTU/H burner and two rear 5200 BTU/H burners. The 3 burner cooktop is also equipped with a control panel.

Refer to manufacturer's user guide for detailed operating and cleaning information.

Kitchen Range & Oven (if so equipped)



NOTE: To help reduce potential condensation or unwanted cooking odors, turn on the overhead kitchen roof vent or the range hood vent (if so equipped)

To prevent damage, always use the manufacturer's recommended size flat bottom pan(s). Generally, the pan should be large enough to cover the burner, but not be more than one inch larger than the burner grate.

Do not use a broiler pan, griddle or any other large utensil that covers more than one burner at a time. This will create excessive heat that may cause melting, sooting or discoloration.

The use of undersized pans could expose a portion of the heating element to direct contact and may result in ignition of clothing. Proper relationship of pans to burner will improve efficiency.

Oven (if so equipped)

The propane gas oven must have 12-volt power to operate. If you have any questions, contact your dealer or our customer service department. **Do not use the oven as a storage area.**

Refer to the manufacturer's user guide for detailed operation, cleaning and safety information.

GAS BBQ GRILL (IF SO EQUIPPED)

⚠ WARNING

- ❑ Be sure to read, understand and follow all information supplied with your recreation vehicle concerning the use of propane before operating the BBQ grill. The propane hose must be correctly connected before lighting the grill. Failure to follow instructions supplied by the grill manufacturer, or use of any components other than those originally supplied with the grill, could result in death or serious injury.
- ❑ If you smell gas: Shut off gas to the appliance; extinguish any open flame; open lid; if odor continues, immediately call you gas supplier or your fire department.
- ❑ The maximum weight limit for the bracket supporting your BBQ grill is 50 lbs. This limit includes the weight placed on the BBQ grill. Exceeding this weight limit could result in injury or property damage.
- ❑ The BBQ grill is for use outside of the recreational vehicle. **Never use this grill inside a compartment or inside of the recreational vehicle.** Before operating the BBQ grill, make sure that it is securely mounted on the support rail attached to the side of the recreational vehicle (if so equipped) or the bumper mounting bracket (if so equipped).

⚠ DANGER

Always open hood before turning on gas and lighting burner, failure to open the hood before lighting could cause an explosion causing property damage, injury, or even death.

Depending on your model, your grill will be mounted with either a bumper mount system, or a rail mount on the side of your recreational vehicle.

Bumper Mount (if so equipped)

Insert the grill mounting bar (with the pins) into the bracket (mounting tube) on the rear bumper of the recreation vehicle.

- ❑ Insert the pin through the hole in the bracket and mounting bar. The pin must be installed to insure the mounting bar is secure during use.
- ❑ Tighten the T-handle on the bracket mounted to the bumper.
- ❑ Set the BBQ grill on the mounting bar by inserting the (2) pegs on the bar into the grill side mounting brackets. Make sure the mounting bar and the grill are securely in place before proceeding with the propane connection.

Rail Mount (if so equipped)

- ❑ Hang the grill bracket on the aluminum mounting strip located on the side of the recreation vehicle.
- ❑ Open the (2) folding arms on the bracket making sure they lock in position.



Bumper Mounting Bracket

- Slide the grill onto the (2) arms against the stops.
- **Make sure the grill is fully on the arms.**
- Insert the retaining pins into the arms.
- To remove the grill, remove the retaining pins and simply slide it off of the bracket arms. Wait until grill has cooled down before removing it.

Refer to the grill manufacturer’s user guide for detailed operating and safety information.

Gas BBQ Grill Prep (if so equipped)

Your recreation vehicle may be equipped with a propane “quick-coupler” connection and support bracket for easy installation of the BBQ grill.

Attaching the “Quick Coupler” Connection

The “quick coupler” is directly connected to the RV propane system. The “quick-coupler” connection is equipped with a positive shut-off valve.

Place the “quick coupler handle in the OFF position and push back the sleeve. The valve handle must be OFF to make the connection.

1. Insert the plug and release the sleeve.
2. Push the plug until the sleeve snaps forward, locking the plug into the socket.
3. Turn the handle ON to allow propane to flow to the drop in stove.

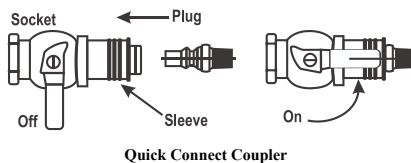

Quick Connect Coupler



Gas Grill & Mounting



Bracket on Support Rail

RANGE HOOD (IF SO EQUIPPED)

If your recreational vehicle is equipped with a range hood, it will be connected to an exterior vent.

The vent has an inner flap with two snaps. This flap can be snapped shut when the vehicle is in motion, or during storage to keep insects, debris, snow, rain, etc. from entering the recreational vehicle.

Anytime the stove inside the recreational vehicle is being used, this flap **MUST** be unsnapped and the range hood turned ON to vent fumes outside the vehicle.

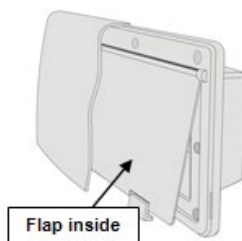

Range Hood Vent

⚠ WARNING

Whenever the stove in the RV is being used: The range hood **MUST** be turned on, and the inner flap **MUST** be unsnapped and free to move. Failure to do so can create an asphyxiation hazard by restricting air flow to this vent.

SECTION 10: APPLIANCES

REFRIGERATOR

The refrigerator is not intended for quick freezing or cooling. We recommend stocking it with pre-frozen or pre-cooled food when possible. The shelves should not be covered with paper or plastic and the food items should be arranged so air can circulate freely. Keep the area at the back of the refrigerator clean and free of debris. Check for obstructions in the exterior refrigerator vent area (i.e., spider webs, bird nests, etc.). Use a soft cloth to dust off the debris.

For optimum efficiency and performance, it is recommended the refrigerator be checked at least twice a year as part of the routine maintenance.

For detailed operating and safety information, refer to the manufacturer's user guide.

Gas/electric models (if so equipped)

WARNING

If you smell propane gas **STOP!** Follow the directions located in your manufacturer's owner's manual and in this manual.

Residential models (if so equipped)



NOTE: If you are using electric to power the refrigerator, make sure you are connected to a 120-volt power source.

CAUTION

The ice maker (if so equipped) should be turned off and the ice tray emptied when power to your recreation vehicle has been shut off. With no power, the ice will melt and water may "pool" in the refrigerator door. When power is restored, the vibration may cause this water to run out of the door and on to the vehicle floor.

3-Way Refrigerators (if so equipped)

Depending on your model, you may have a 3 way refrigerator (12VDC, LP GAS or 120VAC).

WARNING

Converter output (12VDC) is not intended for normal operation of the 3-way refrigerator. When the camping trailer is parked and the power cord is plugged in, set the 3-way refrigerator to "AC power." The "DC mode" is to be used only when traveling and will pull power from the auxiliary battery charge line (if so equipped). When camping without available AC power, utilize the propane mode.

Contact your dealer or Customer Service for details on winterizing your refrigerator.

Cleaning Your Refrigerator

The following are general cleaning guidelines. For detailed information on cleaning your specific refrigerator, refer to the manufacturer's user's guide.

Cleaning The Interior

1. Unplug refrigerator or disconnect power.
2. Hand wash, rinse, and dry removable parts and interior surfaces thoroughly. Use a clean sponge or soft cloth and a mild detergent in warm water.
3. Inside the refrigerator, use a warm water and baking soda solution consisting of approximately 1-tablespoon (15ml) baking soda to 1 quart (1 liter) of water. This solution cleans and neutralizes odors. Rinse and wipe dry.
4. Leave an open box of baking soda in the refrigerator and freezer to help prevent odors.



NOTE: Do not use abrasive or harsh cleaners such as window sprays, scouring cleansers, flammable fluids, cleaning waxes, concentrated detergents, bleaches or cleansers containing petroleum products on plastic parts, interior and door liners or gaskets. Do not use paper towels, scouring pads, or other harsh cleaning tools.

There is no need for routine condenser cleaning in normal operating environments. If the environment is particularly greasy or dusty, or if there is significant pet traffic, the condenser should be cleaned every 2 to 3 months to ensure maximum efficiency.

If you need to clean the condenser:

- Remove the base grille.
- Use a vacuum cleaner with a soft brush to clean the grille, the open areas behind the grille and the front surface area of the condenser.
- Replace the base grille when finished.

Cleaning The Exterior

Painted metal exteriors: wash with a clean sponge or soft cloth and a mild detergent in warm water.

Stainless steel exteriors: wash with a clean sponge or soft cloth and a mild detergent in warm water. Do not use appliance wax, polish, bleach, or other products containing chlorine on stainless steel. Stainless steel can be cleaned with a commercially available stainless steel cleaner. A spray-on stainless steel cleaner works best. **IMPORTANT: Do not allow the Stainless Steel Cleaner and Polish to come into contact with any plastic parts such as the trim pieces, dispenser covers or door gaskets. If unintentional contact does occur, clean plastic part with a sponge and mild detergent in warm water. Dry thoroughly with a soft cloth.**

For silver-accented plastic parts, wash with soap or other mild detergents. Wipe clean with a sponge or damp cloth. Do not use scouring pads, powdered cleaners, bleach or cleaners containing bleach as these products can scratch and weaken the paint finish.

SECTION 10: APPLIANCES

WASHER/DRYER PREP (IF SO EQUIPPED)

If your recreation vehicle was built with washer/dryer prep, be aware the cabinet space provided is intended for the installation of an aftermarket washer/dryer combo unit (customer supplied) only. Please consult your dealer or the manufacturer for installation assistance.

A dryer vent opening must be cut into the sidewall of the RV if installing a dryer. A label has been installed to assist you in placing the vent in the correct location. The label will be located in the area where the dryer will be installed. Instructions on how to cut the dryer vent hole and how to install the dryer vent in the wall of the RV are included in your warranty packet



Dryer Vent Label

⚠ WARNING

Gas dryers should **NEVER** be installed in your recreation vehicle. Dryer prep has been designed for electric dryer operation **ONLY**.

⚠ CAUTION

Do not operate a dryer in the recreation vehicle unless the dryer is properly vented.

WATER HEATER – SEE PLUMBING SECTION

OUTSIDE KITCHEN (IF SO EQUIPPED)

Typically outside kitchens consist of a 2-burner cooktop, refrigerator and sink. For detailed operation and safety information on the outside kitchen appliances, refer to the manufacturer's user guide.

The cooktop will function more efficiently when level.

⚠ WARNING

The maximum weight capacity of the outside kitchen unit is 50 lbs. Setting items on the kitchen unit that exceed this weight limit could cause damage to the unit or result in personal injury.

Outside kitchen access and locking functions may vary depending on your model.

The following applies when using any outside kitchen configuration.

- Make sure all supports are securely in place before using the outside kitchen.
- Before using, make sure the propane connection is properly hooked up and secure.
- Do not leave the cooktop unattended while using.
- Keep all clothing and flammable material away from the cooktop while in use.
- Do not exceed the weight capacity of the outside kitchen unit.
- Disconnect the propane couple before stowing the outside kitchen unit.
- Make sure the kitchen unit is properly stowed and secured, and that the outside kitchen door is securely in place and locked before traveling.

Attaching the “quick coupler” connection

The “quick coupler” is directly connected to the RV propane system. The “quick-coupler” connection has a positive shut-off valve as required by code and standards.

1. Place the “quick coupler handle in the OFF position and push back the sleeve. The valve handle must be OFF to make the connection.
2. Insert the plug and release the sleeve.
3. Push the plug until the sleeve snaps forward, locking the plug into the socket.
4. Turn the handle ON to allow propane to flow to the drop in stove.

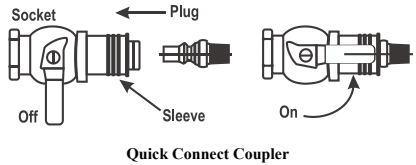

Exterior Refrigerator

Your recreational vehicle may be equipped with an exterior refrigerator in the front storage compartment, or in the outside kitchen (if so equipped). For information on use and safety, refer to the manufacturer’s user guide.

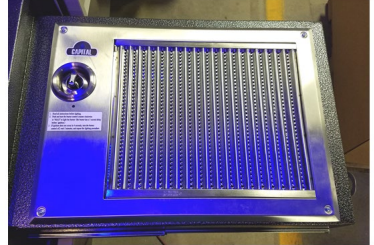

LP Gas Grill (if so equipped)

The outside kitchen may include an LP fueled BBQ grill. This grill is mounted in a pull out drawer. It has a single burner control. It attaches to the LP tank using a quick coupler connection as described above.



NOTE: A drip pan is included with the grill. The drip pan ***MUST*** be used underneath the grill to catch hot grease and liquids dripping from the grill and to prevent injury.

The drip pan attaches to tabs underneath the grill at each end. A handle is mounted in the middle of the drip pan to dump the contents. Refer to the grill user manual for further information.

This grill is *only* available on certain RV models.



Drip Pan

WARNING

- The grill requires proper ventilation. It is designed for RV outdoor use only.
- NEVER put lava rocks or charcoal or anything else on or under the grate. Grill is designed so it does not require those items. Serious injury or property damage can occur by placing foreign objects on the grate.
- Never touch the grate when it is hot. Use the spade (grate handle) supplied with your grill.
- Be sure to read, understand and follow all information supplied with your recreation vehicle concerning the use of propane before operating the BBQ grill. The propane hose must be correctly connected before lighting the grill. Failure to follow instructions supplied by the grill manufacturer, or use of any components other than those originally supplied with the grill, could result in death or serious injury.
- If you smell gas: Shut off gas to the appliance; extinguish any open flame; open lid; if odor continues, immediately call you gas supplier or your fire department.
- The BBQ grill is for use outside of the recreational vehicle. Never use this grill inside a compartment or inside of the recreational vehicle. Make sure the grill is pulled completely out of the drawer before attempting to use it.
- Install the drip pan under the grill to catch hot grease & liquids. Failure to use the drip pan can cause personal injury including burns from hot grease.
- The BBQ grill must be COMPLETELY COOLED before storing it. The grill should be cool to the touch before storing. Storing the BBQ grill before it is completely cool may result in serious injury or property damage.
- Do not cover the cooking surface with a dust cover, a lid, foil, cooking utensil or anything else. Covering the cooking surface can cause an unsafe situation and can lead to serious injury or property damage.

Cleaning The Grill

Make sure the grill is completely cool before cleaning.

Use only non-abrasive cleaners or degreasers designed for use on stainless steel. Apply a stainless steel shine product to all external parts of your grill after cleaning.

Clean the cooking grid with soap and water and a wire brush after each use. Drip pan under the grill should also be cleaned frequently.

The spade (grate handle), drip pan, and cooking grid are all dishwasher safe.

Use the spade (grate handle) to remove the grill grate from the grill. For further information refer to the gas grill user guide or contact Customer Service.

HDTV ANTENNA/SATELLITE SYSTEM(S)

HDTV Antenna (if so equipped)

Your recreation vehicle is equipped with an exterior fixed height high definition TV antenna. This antenna rotates 360° and is capable of receiving any over-the-air (OTA) high definition television signals being broadcast in your receiving area.

The enclosure base for the antenna (inside the RV on the ceiling) will have a knob that can rotate a full 360° to adjust for the best signal coming to the antenna. Your RV may have one of two types of antenna bases mounted to the ceiling.

The first type has a button on the large knob that must be pressed first to unlock it, so it can be turned. The button may have to be held while rotating, and then once released, locks the antenna in position (arrow on the knob indicates antenna direction).

The second type of antenna base has a large knob that must be pushed upward to unlock the antenna. The knob can then be rotated 360° and when released locks the antenna in place.



Base with locking button



Push knob in to rotate antenna



NOTE: The antenna is a fixed height (12" maximum) and cannot be lowered or raised. Trees and foliage will interfere with receiving a strong HDTV signal.

Refer to the HDTV manufacturer's manual for detailed operating and safety information.

Antenna Power Supply (if so equipped)

For good station reception, the antenna power supply must be turned ON to view local television stations. Turning the antenna power supply ON sends 12-volt DC through the cable to the TV roof antenna turning the antenna amplifier ON. Over-the-air HDTV signals are then fed to the TV from the antenna.

Turn the antenna power supply OFF to view cable television or to use a VCR or DVD. The ON/OFF switch is located on the wall plate for the antenna connection. An LED will light to indicate antenna power is ON.



Antenna Power Supply

Satellite (if so equipped)

Please refer to the manufacturer's instructions for setup, care and maintenance.

SECTION 11: ELECTRONICS

Notes:

CLEANING THE INTERIOR

To keep the value of your recreation vehicle, perform regular maintenance using the proper materials and procedures. Using the wrong cleaner may result in damage to the surfaces in your vehicle. Check with the manufacturer's information for the recommended cleaning agent. If in doubt, check to see if the cleaner will cause damage by testing a small area out of sight or contact your dealer for assistance. Do not use flammable liquids or sprays to clean the recreation vehicle.

Décor Glass (if so equipped): Use a glass cleaner to remove smudges, smears and spots. If there is decorative etching on the décor glass, use care when cleaning around that area.

Furniture Upholstery: To retain the value of your recreation vehicle, maintain the furniture upholstery carefully and keep the interior clean. Vacuum the furniture regularly using a soft brush attachment to remove any loose dirt or debris.

Fabric (if so equipped)

It is recommended the fabric be professionally cleaned if it becomes stained or soiled. The professional cleaner should be made aware the fabrics that may have been treated to be fire resistant. For more information, refer to the specific furniture manufacturer's care instructions.

Ultraleather™ (if so equipped): It is recommended the Ultraleather™ be professionally cleaned if it becomes stained or soiled. For more information, refer to the specific furniture manufacturer's care instructions.

Leather (if so equipped): Periodic vacuuming, using a dry cloth to wipe up spills immediately, and using a damp cloth on problem areas, will help to keep your leather furniture in good condition. Leather surfaces can vary, as do the cleaning methods. Refer to the furniture manufacturer's recommendation, or consult a cleaning professional.

It is recommended you do not use any cleaners containing oils, waxes or silicones. Cleaners containing silicone can eventually destroy the finish on the leather. Cleaners containing oils or waxes should not be used as they leave residues on the surface of the leather which can attract more dirt which can eventually lead to cracking

Window Treatments

Fabric – Drapes and valances: Dust occasionally with a vacuum and soft brush attachment. It is recommended the fabric be professionally cleaned if it becomes stained or soiled. The professional cleaner should be made aware the fabrics that may have been treated to be fire resistant.

Window Shades

Shades should be vacuumed periodically to remove dust. It doesn't matter what type of shade or fabric you have, using your vacuum cleaners upholstery brush on low suction will remove most dust and dirt from the shade. Refer to the shade manufacturer's owner's manual for additional and detailed information.

To remove stuck on dust or stains refer to the following guide.

Solar Shields: Use a sponge or soft brush and water to remove stains. A mild cleaning solution can be used to remove tougher stains. Rinse after cleaning by wetting a clean cloth in fresh water, wringing out any excess and wiping the areas where the cleaner was used.

SECTION 12: INTERIOR

Day/Night Shades: Clean with a mild cleaning solution using a sponge or paper towel. Wipe down with water after cleaning and dry thoroughly before raising the shade. Do not use spot remover, household cleaners or detergents to remove soiled spots, as these may cause damage to fabric or loss of color from fading.

Mini Blinds: A simple dry rag may do the trick. If they are especially dirty, you can use cold or warm water to clean them; **never use hot water.**

Fill a spray bottle with water and a tiny amount of soap. Then spray a lint-free towel with the mixture and use the towel to wipe down each slat. While cleaning, try not to bend the slats. They can also be soaked in a bathtub to loosen up any debris so the slats can be wiped down easily.

Roller Shades: Can be easily cared for by simply using soapy water or a mild cleaning solution on spots. However try a small area first. Harsh household cleaners or detergents may cause damage to fabric or loss of color. It is our recommendation to dust the rails and fabrics of the shades on a regular basis. Shades should be kept in the closed or up position when not in use, to maintain pleat retention and minimize dirt and soil build-up. Do not store



NOTE: If your recreation vehicle must be stored for an extended period of time, store shades in the up position and cover your windows with additional protection (I.E. Cut out cardboard).

shades in the down position. This may cause some loss of pleat retention if the shades are not operated on a consistent basis.

Cabinetry & Tables

To keep hardwood doors, cabinet fronts and hardwood tables looking like new regularly dust with a soft cloth dampened with a cleaning polish or mild detergent solution. Avoid using ammonia based products or silicone oils as they may cause damage if used over a long period of time.

The finish is durable and resistant to most household spills. However, spills should be wiped up promptly to avoid potential problems. Excessive prolonged exposure to direct sunlight, high temperatures and high humidity can cause damage to both the finish and the wood itself. These should be avoided.

Interior Wall Panel

Please contact your dealership service department for assistance in repairing décor paneling. If deep scratches occur on the wall panel, putty sticks can be used to cover scratches on wood surfaces. These can be obtained from local hardwood stores and lumberyards.



CAUTION

Do not use abrasive cleaners as they may cause the vinyl to scratch and become dull. Do not use cleaners that contain bleach

To clean, use a mild solution of soap and lukewarm water with a soft sponge or cloth. Wipe dry with a soft, clean cloth.

ABS Plastics

Dust and wipe clean with soft, damp cloth or chamois, wiping gently. Do not use gritty or abrasive particle soaps or scouring compound to clean ABS plastic. Avoid using “citrus” or biodegradable cleaners that contain “D-Limonene” as they may damage plastic materials.

SOFA & DINETTE

Your recreation vehicle may be equipped with one of the following sofa styles.

Hide-A-Bed Sofa or Sofa Sleeper

The hide-a-bed sofa functions much the same as a regular residential hide-a-bed sofa. To make the hide-a-bed sofa into a bed, remove the seat cushions and pull the sofa back towards you firmly and gently. Activate (or deflate) the air mattress (if so equipped) using the supplied furniture manufacturer’s instructions. To convert the hide-a-bed back into the upright sofa position, reverse the process.

Jack Knife Sofa

The Jack Knife sofa functions much the same as a residential futon. To make the sofa into a bed, lift up on the bottom seat cushion and pull it towards you. The sofa back will drop down to provide a sleeping surface. For additional comfort and to reduce fabric damage, you may want to place a cover or air mattress (customer supplied) over the sofa when it is in the sleeping position.

Trifold Sofa

The Trifold Sofa offers very similar features to the traditional hide-a-bed. The following illustrations detail converting the sofa into a bed.



1. Remove tri-fold sofa pillows and set aside



2. Using the strap handle, pull sleeping surface up, then out.



3. While sleeping surface is up, gold out legs. Extend sleeping surface until grounded.



4. Once sleeping surface is grounded, fold headboard down flat.

Cube Sofa

The Cube Sofa functions similar to a residential futon. The slanted back pillows offer numerous options as a sofa, along with the ability to extend the cushions for additional sleeping space.

SECTION 12: INTERIOR

Booth Dinette (if so equipped)

The dinette is designed to seat up to four adults. Depending on your model, there may be a storage area in the dinette bench. To access this storage, remove all the cushions and lift up on the bottom seat support. **If the bottom seat support is secured closed with screws, do not remove the seat support or use this area for storage.**

The dinette seats that are secured with screws contain factory installed equipment and should only be accessed by a qualified service technician.

Converting the dinette to the bed position

Remove all the cushions from the booth dinette. Lift up the tabletop and remove the detachable table legs. Place the tabletop on the ledges provided between the booth dinette benches. Lay the seat back cushions against the back of the dinette bench. Lay the dinette seat bottom cushions in between the seat back cushions. The area where the cushions meet should be slightly raised. Push the raised cushion ends down gently as the cushions are designed to fit snugly. Reverse this process when converting back to the booth dinette.

Free-Standing Table & Chairs (if so equipped)

The free-standing dinette table can be positioned to seat up to four people. To prevent damage, the free-standing dinette chairs should be fastened securely at the dinette table when you are traveling

PANTRY OR HUTCH (IF SO EQUIPPED)

Your recreation vehicle may have a pantry or hutch that you can use for storage. Make sure all items stored in the pantry or hutch are secured to prevent shifting during travel. This cabinetry has been designed to accommodate the normal camping items which may be bulky but not necessarily heavy. **Remember your recreation vehicle's load capacity is designed by weight, not volume, so you cannot necessarily use all available space.**

If your pantry or hutch has sliding pantry shelves, they have been equipped with a locking mechanism to keep them in place during transit. To secure the shelf in place, push it all of the way in until the latch tab clicks into place. Always pull out slightly on the shelf to make sure that it is stationary and secure in the transit position. To release the shelf, push in on the tab and pull the shelf slowly towards you.

WARNING

Your RV's load capacity is designated by weight, not by volume, so you cannot necessarily use all available space when loading the vehicle. Do not exceed your GVWR and ensure you are loading the vehicle as evenly as you can for the best possible handling. Ensure heavy items are secured so they do not shift during travel.

COUNTERTOPS

To prevent permanent damage

- Always use hot pads or trivets under hot pans, dishes, or heat producing appliances such as frying pans. Heat will damage the countertop.
- Use a cutting board to prevent unnecessary damage to the countertops. Do not cut directly on the solid surface countertop.
- Avoid harsh chemicals such as drain cleaners, oven cleaners, etc.

- Do not let cleaners with bleach set on the top. Wipe them off promptly.

For additional information on the removal of difficult stains or surface damage repair, refer to the countertop manufacturer's user guide.

Your recreation vehicle may be equipped with one or both of the following countertops.

Laminate Countertops (if so equipped)

Glass rings, food spills, water spots and smudges usually wipe off with a damp sponge. Stubborn stains can be removed with a general-purpose spray cleaner. Some stains can be removed by squeezing fresh lemon juice over the stain and allowing the juice to soak for approximately forty-five minutes. After 45 minutes, sprinkle baking soda over the lemon juice and rub with a soft cloth.

Solid Surface Countertops (if so equipped)

Soapy water, ammonia based cleaners (not window cleaners as they can leave a waxy build up that may dull the surface) or commercially available solid surface cleaners will remove most dirt and residue from all types of finishes. A damp cloth followed by a dry towel will remove watermarks.

Difficult stains can be removed from the matte finish with a green Scotch Brite® pad and a mild abrasive cleaner. Disinfect the surface periodically with diluted household bleach (one part water to one part bleach).

For cuts and scratches, sand the matte finish lightly with (220) fine grit sandpaper until the cut or scratch is gone. Restore finish with a green Scotch Brite® pad and mild abrasive cleaner.

Run cold water when pouring hot/boiling water into the sink.

Solid surface sink maintenance

Occasionally, clean the solid surface sink by filling one-quarter full with a 50/50 water/bleach solution. Let soak for 15 minutes, and then wash sides and bottom of sink as solution drains.

FLOORING

Always test a cleaning agent in an inconspicuous area for colorfastness.

Carpet

Vacuum your carpet regularly. It is important to remove loose soil and debris while it is on the surface. Heavily traveled areas (i.e., walkways, areas in front of the furniture) may be protected with small throw rugs to prolong the life of the carpet.

Prompt attention to spots and spills is essential. Remove as much of the spill as possible. Absorb wet spills as quickly as possible by blotting repeatedly with white paper or cloth towels.

Refer to the manufacturer's guide for detailed cleaning information, or contact a cleaning professional.

Vinyl flooring

Periodically vacuum or sweep to remove dirt and gritty particles. Although most common spills will not permanently stain the vinyl floors, they are usually easier to remove if wiped up before they set. Blot with a paper towel and wipe clean with a damp cloth. Do not use dish detergents or vinegar and water because they will dull your floor.

SECTION 12: INTERIOR

To care for the vinyl floor covering, use a damp mop with water and a mild cleaner on the entire floor. **DO NOT SOAK THE FLOORING.** Use care to avoid wetting the carpet edges. To avoid problems of “yellowing” linoleum, the flooring manufacturer recommends avoiding cleaners that contain oil based solvents (i.e. lemon oil, Murphy’s Oil Soap, etc.).

MURPHY BED (IF SO EQUIPPED)

Your recreational vehicle may be equipped with a folding Murphy bed. When in the closed position, the bed is stored in the wall allowing for more living space within the vehicle. When you want to use the bed, the sofa folds flat and the bed can be pulled down over the sofa into the sleeping position.



Stored Position



Sleeping Position

⚠ CAUTION

The slide out **must be fully extended** before putting the Murphy bed in the sleeping position. The Murphy bed **must be in the stored position** before the slide out can be moved to the in (travel) position. Failure to do so may result in injury or property damage

This label has been installed in your recreational vehicle at the foot end of the Murphy bed. **It should not be removed.**

Unfolding The Sofa

With the slideout fully extended, unfold the sofa into the flat position.

- Standing at the side of the sofa, grasp the front of the seat cushion and the top of the back cushion (Fig. A arrows).
- Lift up on the seat cushion while pulling the top of the back cushion in toward the seat. The seat and back will form a “V” shape. (Fig. B).
- Pull the seat cushion out away from the front of the sofa into the flat position (Fig. C).



NOTICE

The murphy bed must be folded up and secured in place before moving the slideout to the in position.

Moving the slideout before the bed is properly stored and secured may result in damage to the bed and /or slideout.

Lowering The Murphy Bed

- Unlatch the “D” bolt latches on each side of the bed at the footboard (in the stored position). This will release the Murphy bed allowing it to unfold.
- Firmly grasp the handle on the footboard of the Murphy bed, and pull it towards you.
- The bed will begin to unfold. Pull it all the way down so the footboard rests on the floor.
- When the bed is in the sleeping position, locate the web straps with snap hooks on the footboard of the bed (there is one on each side of the bed). Attach (both) snap hooks to the metal loops located on the sofa arms. **These straps and loops keep the bed from folding up while in use.**

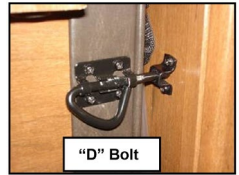

NOTE: The straps are adjustable. They have been installed at a length that holds the bed securely in place and allows ease of attaching the snap to the metal loops.

⚠ WARNING

Snap hooks must be attached to the steel rings on the sofa arms before using the bed. Failure to attach these snap hooks to the steel loops on the sofa can result in serious injury or property damage.

MAKE SURE THE SAFETY STRAPS AT EACH SIDE OF THE FOOTBOARD ARE ATTACHED TO THE STEEL LOOPS ON THE SOFA ARMS BEFORE PUTTING ANY WEIGHT ON THE BED.

⚠ CAUTION

This Murphy Bed is equipped with two hold-down methods for use when the bed is lowered in the sleeping position.

1. An automatic latching system and
2. Manual safety straps

Be sure both of these methods are used and completely engaged to prevent the bed from lifting or folding up unexpectedly which may result in personal injury.

Consult your owner's manual and/or your authorized independent dealer for additional information. 0303414



The label shown here is located next to the slide out controls inside the entrance door. **It should not be removed.**

Remove the straps holding the mattress to the bed frame by unsnapping the two plastic buckles on top of the mattress. These straps can be stored on the side of the mattress, or tucked between the headboard and the mattress. Release the mattress hook from the foot of the bed.

SECTION 12: INTERIOR



NOTE: On some models, the Murphy bed may lock in place when lowered to keep it from flipping up unexpectedly. In order to release the bed, a lever must be pulled first. There are two types of levers. One is a “T” handle installed in the side dresser and the other is a lever built into the side of the couch. When the lever is pulled, the bed can be returned to the folded or stored position. Make sure to latch the sliding “D” bolts on each side when bed is returned to the upright stored position.

Storing The Murphy Bed

- Attach the “Y” strap that holds the mattress to the bedframe. Pull the straps with the buckles up from the head of the bed and snap them to the “Y” strap. Secure the snap hook at the footboard. **MAKE SURE THE SAFETY STRAPS AT EACH SIDE OF THE FOOTBOARD ARE STILL ATTACHED TO THE STEEL LOOPS ON THE SOFA ARMS BEFORE PUTTING ANY WEIGHT ON THE BED.**
- Unhook the safety strap snap hooks from the steel loops on the arms of the sofa.
- Release the locking lever (if applicable) so bed can be raised.
- Push the bed back up into the storage position.
- Secure the two “D” bolts on each side of the bed.
- Flip the sofa back up into the seated position:

⚠ WARNING

Keep hands and fingers away from the collapsing footboard and struts when pushing the bed back in to the storage position.

- Firmly grasp the edge of the top cushion and the front edge of the seat cushion.
- Push the cushions down and towards each other so they form a “V” shape.
- While holding the cushions in this “V” shape, rotate the sofa back towards the wall and the cushions will revert to the seated position.

BED STORAGE

Additional storage has been provided under the bed. It is equipped with gas struts to assist with easy access. To access the storage area, grasp the end ledge at the foot of the bed and lift carefully. To close, carefully push down on the bed slowly easing it to the closed position.

⚠ CAUTION

Before lifting, be sure there is nothing on the bed that will restrict its movement or add extra weight. Use caution when opening or closing the bed to keep hands and fingers at the end ledge provided (not on the side or further back than necessary) to avoid pinch points.

The bedroom electric slide room system may be located under the bed. Use care not to obstruct the slide room system when using the under bed storage area.

CLEANING THE EXTERIOR

To protect your recreation vehicle's exterior finish, wash it often and thoroughly.

For recreation vehicles with painted exterior graphics: If desired you may wash and wax your vehicle 60 days after purchase. The exterior paint does need time to cure before any wax is applied to the exterior surface. Careful maintenance for the first 60 days will assure a long lasting durable finish.

Your recreation vehicle is exposed to many environmental conditions that have an adverse affect on the paint finish:

- Road Salt and Sodium Chloride
- Road Tar / Bugs
- Bird Droppings / Tree Sap
- Industrial Fallout / Acid Rain /Pollution
- UV Exposure and Moisture

The most common problems resulting from these conditions are corrosion, staining, and chemical spotting. Generally, the longer the foreign material remains in contact with the exterior finish, the more extensive the damage. These problems can be minimized by regularly scheduled washing and polishing. Wash your recreation vehicle as soon as possible if it becomes contaminated with foreign material.

Avoid parking under trees or near ocean sea salt. Ice or snow should not be scraped from the painted surface: Brush off!

Gravel roads should be avoided.

Anti-freeze, gasoline or washer solvents if spilled on the painted surface should be rinsed off with water immediately. Bugs and bird droppings should be rinsed off daily.

Washing

Commercial washing should be avoided. Wash with cold water using a mild liquid soap. Dry wiping with a dry cloth is not recommended.

Make sure the RV's surface temperature is cool, under 90 F, and out of direct sunlight. A shaded area is ideal for washing your vehicle as direct sunlight causes water spotting. Use a mild soap, detergent or car wash shampoo. Try to avoid combination wash-n-wax products as these waxes can cause build up and are designed for smaller surfaces. Have two dedicated sponges or wash mitts: one for the exterior walls and one for the wheels and under carriage. Brushes or wash mitts made of plastic bristles are acceptable for use on tires and wheel wells, but are not intended for use on the exterior walls. Avoid using such items on painted surfaces as they will damage the finish. Wash the wheels and wheel wells first as this removes heavy dirt and debris and prevents it from splattering on panels. Wet the entire area down to remove loose dirt and grime, then hand wash one area at a time using your dedicated paint finish sponge or wash mitt. Wash from the top and work your way down, rinsing frequently to minimize grit abrasion. Follow with a final rinse of water. This process will remove most contamination from the recreation vehicle's surface.

For stubborn stains such as road tar or bug stains, use an ammonia based glass cleaner or a small amount of rubbing alcohol on a damp cloth followed immediately by warm soapy water, and rinsing with clean water. This may not dissolve the road tar, but it will loosen tar and bug stains and remove them from the surface.

Do not use solvent based cleaners on bird droppings or tree sap as these are water based stains. They can be dissolved using ammonia based glass cleaner, warm soapy water and

SECTION 13: EXTERIOR

a little “elbow grease”. Once again, after removing stubborn stains immediately rinse with clean water.

Drying the recreation vehicle is just as important as washing your vehicle. Tap and well water contain many chemicals that could water stain your vehicle’s finish.

We suggest using a damp natural or synthetic chamois. There are other drying products such as lint-free micro-fiber towels that work just as well.

During cold weather

Salt and other chemicals that are spread on winter roads in some geographical areas can have a detrimental effect on the recreation vehicle’s underbody. **If your recreation vehicle is exposed to these conditions, spray the underbody with a high-pressure hose every time you wash the exterior of your recreation vehicle.**

Take special care to remove mud or other debris that could trap and hold salt or moisture. After washing your recreation vehicle, wipe off all water drops from the rubber parts around the slideout and doors.



NOTE: When the slideout or door is frozen, opening it by force may tear off or crack the rubber gasket that is installed around the slideout or door. Therefore, pour warm water on the gasket to melt the ice (wipe off the water thoroughly after opening the slideout or door). To prevent the weather stripping from freezing, treat it with a silicone spray.

Waxing

Wax your recreation vehicle once or twice a year, or when painted surfaces do not shed water well. Use a soft cloth to apply a small amount of wax to the painted surfaces. After the wax has dried, polish the recreation vehicle with a dry, soft cloth.

Do not wax your recreation vehicle in direct sunlight. Wax it after the surfaces have cooled.

Do not apply wax to any area having a flat black finish as it can cause discoloration. If the finish has been stained with wax, wipe off the area with a soft cloth and warm water. When waxing the area around the various openings, do not apply any wax on the weather strip. If it is stained with wax, the weather strip cannot maintain a weatherproof seal around the opening.

CAUTION

- Do not use waxes containing high-abrasive compounds. Such waxes remove rust and stains effectively from the paint work, but they are also harmful to the luster of the painted surface since they scrape off the coating. Further, they are detrimental to glossy surfaces, such as the grille, garnish, moldings, etc. do not use gasoline or paint thinners to remove road tar or other contamination to the painted surface.
- Do not use a buffer and a buffing compound as it may damage the exterior surface. Please contact a professional paint body shop for assistance.

Polishing your recreation vehicle

If painted surfaces have been severely damaged and have lost their original luster and color tone, polish the surface lightly with a fine polishing compound. Avoid limiting your polishing to the damaged surface only; polish a somewhat wider area, moving the polishing cloth in one direction. After polishing, flush the compound from the surface and apply a coat of wax to regain a beautiful luster.

Damaged paint

To prevent corrosion, touch up small cracks and scratches in the paint coat as soon as possible with touch-up film or paint. Carefully check the body areas facing the road and the tires for damage to the paint coat caused by flying stones, etc. Use the closest automotive paint (available locally) match possible when touch-up paint is needed.

Cleaning plastic parts

Use a sponge or chamois to clean plastic parts. Use warm water and a soft cloth or chamois to remove any white residue from dark colored plastic surfaces. Do not use a scrubbing brush, other hard tools, or wax containing abrasives as they may damage the plastic surface.

CAUTION

Do not allow plastic to come into contact with brake fluid, engine oil, grease, paint thinner, or battery acid. These will damage plastic. Use a soft cloth and a mild detergent solution to wipe away any such contact.

Chrome parts

To prevent chrome parts from spotting or corroding, wash with water, dry thoroughly, and apply a non-abrasive automotive wax. If the chrome is severely damaged or pitted, use a commercially available chrome polish product.

FRAME

Sand, pebbles, objects on the highway, climate (salt air exposure) or ice inhibiting chemicals used during the winter months will damage the paint, inviting rust and other deterioration. Periodically inspect the exterior exposed areas, clean and repaint the frame members occasionally and whenever you notice rust or paint chipped away, to insure protection.

E-Z LUBE OR SUPER-LUBE AXLE (IF SO EQUIPPED)

The E-Z lube or Super-lube feature on your axles provides the ability for the bearings to be periodically lubricated without removing the hubs from the axle. This feature consists of axle spindles that have been specially drilled and fitted with grease zerks in their ends. When grease is pumped into the zerk, it is channeled to the inner bearing and then flows back to the outer bearing and eventually back out the grease cap hole. If you have further questions, consult with your dealer.



NOTE: The convenient lubrication provisions of the E-Z lube or Super-lube feature must not replace periodic inspection and maintenance of the bearings. Use a hand-operated grease gun; improper use of a commercial grease gun may damage the seals.

SECTION 13: EXTERIOR

EXTERIOR ROOF & SIDEWALL VENTS

Inspect the roof vents (including sealants) for cracks and keep them clean. Inspect the refrigerator and holding tank vents for blockages from bird nests, spider webs, leaves, etc. All exterior access doors and vents need to be kept clean and free of obstructions (i.e., insect nests, mud daubers, etc.) while the appliances are in use.

WINDOWS

Any ventilating window may permit water inside, especially during heavy rainstorms. Condensation will also cause water to accumulate on windows and in the tracks.

The window “glass” can normally be cleaned with a sponge and water. Use glass cleaner to remove wax, oil, grease, dead insects, etc. After washing the glass, wipe it dry with a clean, soft cloth.

EXTERIOR LADDER (IF SO EQUIPPED)

Your recreation vehicle may be equipped with an exterior roof ladder. The RV roof has decking under the rubber roof membrane to allow you to walk on the roof (with caution) to do maintenance.

⚠ WARNING

- ❑ If your recreation vehicle is equipped with a roof ladder, do not leave items attached to it while traveling. **DO NOT** exceed the weight rating of the ladder. (Ladder weight capacity label is located under the bottom step of the ladder) There should never be more than one person on the ladder at the same time.
- ❑ **Self-Storing ladders:** Make sure to pull all (there may be up to 4) pins to unlock the ladder. All pins **must be re-inserted** when locking the ladder open for use. Failure to do so may result in serious personal injury.

Some models may be equipped with a self-storing ladder mounted to the side of the vehicle.

Self-Storing Ladder operation

1. Pull all the locking pins (arrows) out of the ladder brackets (**Fig. A**).
2. Pull the ladder down and toward you and it will swing away from the RV.
3. When the brackets are extended (**Fig. B**), re-insert the pins (arrows) to lock the ladder in place while in use.
4. To return the ladder to the storage position; pull the locking pins and push the ladder up and in towards the RV.
5. When the ladder is in the storage position, re-insert all locking pins to prevent the ladder from opening while traveling.

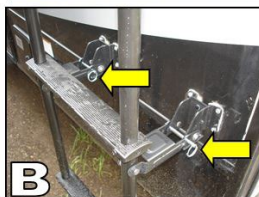
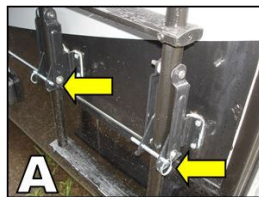

⚠ WARNING

LADDER CAPACITY MAXIMUM

300 LBS (136 KG)

- DO NOT exceed the ladder maximum weight rating.
- The maximum rating includes the person's weight PLUS weight of items carried.
- When climbing:
 - Always face the ladder.
 - Climb slowly with weight centered between side rails.
 - Keep a 3 point contact on the ladder at all times.
 - 3 Point contact - two hands and a foot or two feet and one hand.
- Keep hands free.
 - Use of accessories such as lanyards to keep carried items tethered will keep hands free and prevent falling items.
 - Heavy or bulky items should be brought up only after reaching the roof.
- Do not use the ladder if damaged in any way.

Failure to follow these instructions can lead to ladder collapse, a fall, or dropped items which could result in death or serious injury.

SEALANTS

⚠ CAUTION

Failure to properly maintain or reseal your recreation vehicle may result in serious water damage to the roof and other parts of the recreation vehicle. This damage is not covered by the **Towable Limited Warranty**.

Sealants perform a very important function and should be inspected closely and regularly maintained. We incorporate many different types of sealants, including butyl/putty, black butyl-encapsulated foam, silicone (clear and colored), roof sealant and foam. In general, sealants do not have "set" lifetimes. Varying environmental factors affect the pliability and adhesiveness of sealants.

You or your dealer must:

- Inspect all sealants, a minimum of every six months. Make sure to check the roof and all four sides of the recreation vehicle including all moldings, doors, vents and exterior attachments. A quick walk around the recreation vehicle before leaving may help prevent potential problems during trips and vacations.
- Have the sealant replaced if you notice any cracks, peeling, voids, gaps, breaks, looseness or any sign of physical deterioration. Reseal at least one time each year as preventative maintenance.
- Always use the same type of sealant that was removed. Your dealer recreation vehicle service or parts manager can help you obtain the correct sealant(s).

SECTION 13: EXTERIOR

The sealants may become damaged due to road vibration, ultraviolet exposure, air pollution, freezing temperatures and exposure to other elements. If deteriorated, repair immediately to prevent damage.

If you notice water inside the recreation vehicle, immediately have the dealer check for the source of the leak. Failure to correct the leak may result in serious damage to your recreation vehicle; this damage may not be warrantable.

Although the following diagrams may not accurately reflect the exact model of your recreation vehicle, make sure you inspect all sealants as indicated in the text. If you have questions and/or need assistance with sealing your recreation vehicle, consult with your recreation vehicle dealer.

TRAVEL TRAILERS - SEALANT DIAGRAM

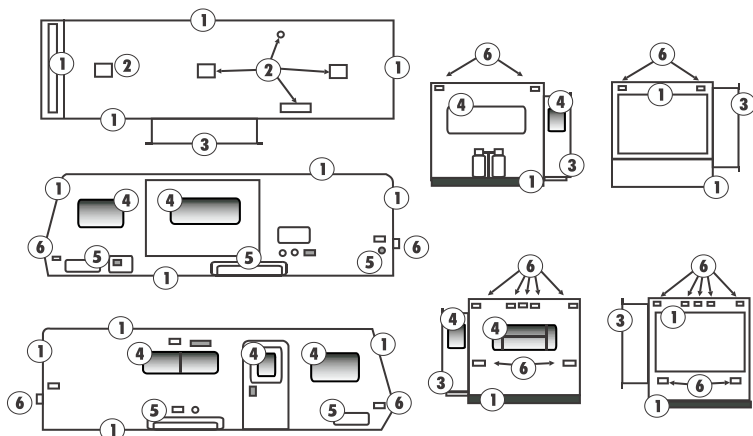

1. Trim Edges

2. Roof items

3. Slideout Roof/Floor

4. Windows/Doors

**5. Storage Compartments/
Access Doors/Wheel Wells**

6. Lights

TRAVEL CHECKLIST

Following is a preliminary list of items that need to be checked before leaving your home or campsite. This is a general list, which you may want to customize as you determine your own needs.

Safety

- Make sure you follow all safety precautions noted in this owner's manual and in any manufacturer's operators manual when preparing to travel.

Maintenance

- Inspect seals and reseal as needed.
- Have the propane system checked for leaks by your dealer.
- Check wheel lug nuts after first two hundred miles and at specified intervals to listed torque specifications, re-torque as needed.
- Have brakes adjusted by a qualified service technician.
- Sanitize the fresh water system.
- Test the safety alarms.

Before leaving home (or campsite)

- Make sure all tow vehicle fluids are at proper levels. Check the engine oil, transmission fluid, engine coolant, power steering fluid and wind shield washer fluid.
- Check the lights on the RV. Have someone observe the operation of all exterior lights while you activate the controls. Check the turn signals and brake lights.**
- Examine the tires for excessive tread wear or uneven wear patterns. Check for stones, nails, glass or other objects lodged in the tread. Inspect for tread cuts or sidewall **cracks**.
- Check tire pressure** (including spare) and correct according to manufacturer specifications.
- Check wheel lug nuts for tightness.**
- Inspect safety chains for signs of wear.**
- Inspect and work all interior and exterior latches and locks (lube if necessary).
- Make sure the batteries are fully charged and installed correctly.
- Inspect the power cord and carefully clean the contacts if necessary. Plug in the power cord to an appropriate power source.
- Turn on the interior lights and check outlets for polarity. If needed, replace any blown fuses. Check the circuit breakers and test the GFCI.
- Check the propane cylinder gauge to make sure there is propane available. Make sure the propane cylinder is in place and secure for transport.
- Inspect and turn on the propane system.** If you have any questions, contact your dealer or a qualified propane service representative for assistance. If the propane system is functioning properly, test any pilot lights or direct spark ignition features.
- Inspect and test all safety detectors.** If needed, replace any drained or discharged batteries. If you have a defective or damaged safety detector, replace it immediately.
- Inspect the leveling jacks (if so equipped) for operation. If needed, perform maintenance as specified by the leveling jack manufacturer.
- Test all exterior and interior lights. Replace any bulbs if they are burnt out.
- Wash the exterior of the RV. Do a sealant inspection and repair as necessary.
- De-winterize and **sanitize** the fresh water system.
- Connect your tow vehicle to the RV and test all connections and lights. Test brakes.**

SECTION 14: TRAVEL/CAMPING/STORAGE CHECKLISTS

Before leaving the campsite

- Check the area under the RV after overnight parking and look for water or other fluid leaks. If leaks are detected, find the cause and correct it immediately.
- Turn off propane tanks.
- Empty black and gray holding tanks, rinse as needed (if so equipped).
- Retract awning and secure in place for transport (if so equipped).
- Close roof vents.
- Close windows & latch blinds.
- Disconnect any cable TV or phone hookup, and lower the TV antenna (if so equipped).
- Turn off interior lights.
- Turn off water heater, water pump, furnace and appliances.
- Snap the Range Hood vent closed (if so equipped).
- Latch drawers, cabinets & doors. Counter items put away or tied down.
- Fasten and secure the furniture for travel (if so equipped).
- Refrigerator door locked (if so equipped). Set to 12-volt (if applicable).
- Secure any loose, heavy or sharp objects in the RV or exterior compartments.
- Disconnect the power cord and ensure it is stored correctly.
- Disconnect any water connections.
- Fasten all interior and exterior doors securely. Lock them (if so equipped).
- Move slideout(s) in and lock it in place (if so equipped).
- Walk around your RV one last time to make sure everything is stored away and the baggage compartments are closed and locked.
- Retract leveling jacks to the travel position (if so equipped).
- Retract step.
- Secure and lock the entrance door.

RV STORAGE

Properly preparing your RV for storage during periods of non-usage will prevent problems from arising. It will also make it easier to get started again for the following camping trip or season. To prevent costly freeze-ups, winterize the plumbing system when it will not be in use for an extended period of time, especially if it is stored in colder climates.

Prior to Storage

- Store your RV indoors, under a roof or a “breathable” cover for use during storage.
- To prevent weather checking and other UV damage, cover tires exposed to sunlight.
- Thoroughly wash the interior and the exterior of your RV.
- Do not use the stabilizing jacks during storage.
- Check the roof and other surfaces to ensure there is no damage and potential leakage that might otherwise go unnoticed.
- Inspect and seal off any area that offers an entry point for rodents, birds or insects. Cover all external outlets (i.e. furnace, vents etc.). Damage from birds, rodents, insect, etc., is not covered under the “Towable Limited Warranty” applicable to your RV.
- Close all windows and roof vents.
- Cover the roof air conditioner (if so equipped).
- Close the propane cylinder valve(s). We recommend using a propane cylinder cover, and to make sure the propane regulator is covered. If is equipped with a gas/electric DSI range, light a range gas burner to consume any gas remaining in the lines. Once the flame extinguishes itself, turn the burner valve OFF.
- Drain all water lines. Make sure the RV is winterized

SECTION 14: TRAVEL/CAMPING/STORAGE CHECKLISTS

- Drain and flush all holding tanks (fresh water, gray water, black water and/or hot water tanks).
- Adding fuel stabilizer to the generator (if so equipped) will aid in preventing condensation and fuel varnishing.
- Disconnect 120-volt AC power to the RV.
- Remove all batteries from the RV and store in a place where they will not freeze. A battery that has been frozen will never hold a proper charge.
- Turn all cushions on edge to prevent the moisture/mildew buildup during storage.
- Turn off 12-volt DC/120-volt AC/propane to the refrigerator; defrost and clean. Block the doors open so air can circulate and prevent mildew, or use crumpled newspaper or open boxes of baking soda in the refrigerator to eliminate odors during storage.
- Remove all perishables from the cabinets. Leave the cabinets and doors ajar to allow air circulation and prevent mildew and musty odors.
- Lubricate locks and hinges on exterior doors.

During Storage Period

Remove snow from the top of your RV to prevent damage to the unit's structure.



CAUTION

Excessive snow, 8" or more, or ice, 2" or more, places excessive weight on the RV roof. Remove excessive snow or ice as needed. Care **MUST** be exercised to not damage the roof material when removing snow & ice. Excessive weight can damage the roof, seals, etc. Water leaks and poor fit or operation are the results of this damage.

SECTION 14: TRAVEL/CAMPING/STORAGE CHECKLISTS

Notes:

FEATURED COMPONENTS QUICK REFERENCE CHART

Your recreation vehicle may be equipped with some of the items listed below. This is a partial listing and it is not intended to cover all components. All information is the latest available at the time of publication. Jayco reserves the right to change any of the following information without notice.

COMPONENT	MANUFACTURER	WEBSITE
Air Conditioner	Coleman-Mach	www.airxcel.com/coleman-mach
Awning	Lippert Components Carefree of Colorado Dometic	www.lci1.com www.carefreeofcolorado.com www.dometic.com
Axle	Lippert Components Dexter Axle	www.lci1.com www.dexteraxle.com
DVD/CD	See manufacturers' user guide	
Entrance Step	Lippert Components Mor Ryde Step Above	www.lci1.com www.morryde.com
Fan, Exhaust 12V	Ventline Maxx Fan	www.ventline.com www.airxcel.com/maxxair/products/fans
Fire Extinguisher	See manufacturers' user guide	
Furnace	Atwood/Hydroflame	www.atwoodmobile.com
Microwave	See manufacturers' user guide	
Monitor Panel	KIB Enterprises	www.kib.us
Outside Shower / Utility Center	B & B Molders	www.bandbmolders.com
Propane Tank	Manchester Tank	www.mantank.com
Propane / Carbon Monoxide Alarm	See manufacturers' user guide	
Propane Regulator	Dehco	www.dehco.com
Range/stove/cooktop	Atwood Suburban Dehco	www.atwoodmobile.com www.airxcel.com/suburban/products/cooking www.dehco.com
Range hood	Ventline Inc.	www.ventline.com
Refrigerator	Norcold Frigidaire Samsung Dometic GE	www.norcold.com www.frigidaire.com www.samsung.com www.dometic.com www.ge.com
Smoke Alarm	See manufacturers' user guide	
Tank Sprayer/BLK	B & B Molders	www.bandbmolders.com
Thermostat	Coleman Mach	www.airxcel.com/coleman-mach

SECTION 15: ADDITIONAL INFORMATION

Toilet	Thetford Corp.	www.thetford.com
TV	See manufacturers' user guide	
TV Antenna	Winegard Company	www.winegard.com
	King Jack	www.kingconnect.com
Water Heater, Tank DSI	Atwood Greenbrier	www.atwoodmobile.com
Water Heater, Tankless	Girard Systems	www.greenrvproducts.com
	Truma AquaGo	www.truma.com
Water Pump, 12V	Shurflo East	www.shurflo.com

VEHICLE MAINTENANCE RECORD

Make:	
Model:	
Model Year:	
Vehicle Serial#:	

Service Date	Mileage	Work Performed	Performed By	Notes

SECTION 15: ADDITIONAL INFORMATION

Jayco
Ownership Notification
Fax Form To: (800) 825-7876

ATTENTION!

Federal record keeping laws require that we maintain a file of owners of our product. Your cooperation in filling out this form will be appreciated.

Change of Owner

Transfer of Limited Warranty
(see limited warranty for details)

Model Information:

Serial#: _____

Chassis #: _____ Odometer Reading _____
(Motorized only)

New Owner Information:

Purchased Date: _____

Name: _____

Address: _____

City: _____ State/Province: _____ Zip Code _____

Phone # _____ E-Mail Address _____

Previous Owner Information:

Purchased Date: _____

Name: _____

Address: _____

City: _____ State/Province: _____ Zip Code _____

Phone # _____ E-Mail Address _____

Notes: